

# LS ELECTRIC

## A.G. Dağıtım Ekipmanları Fiyat Listesi Nisan 2026

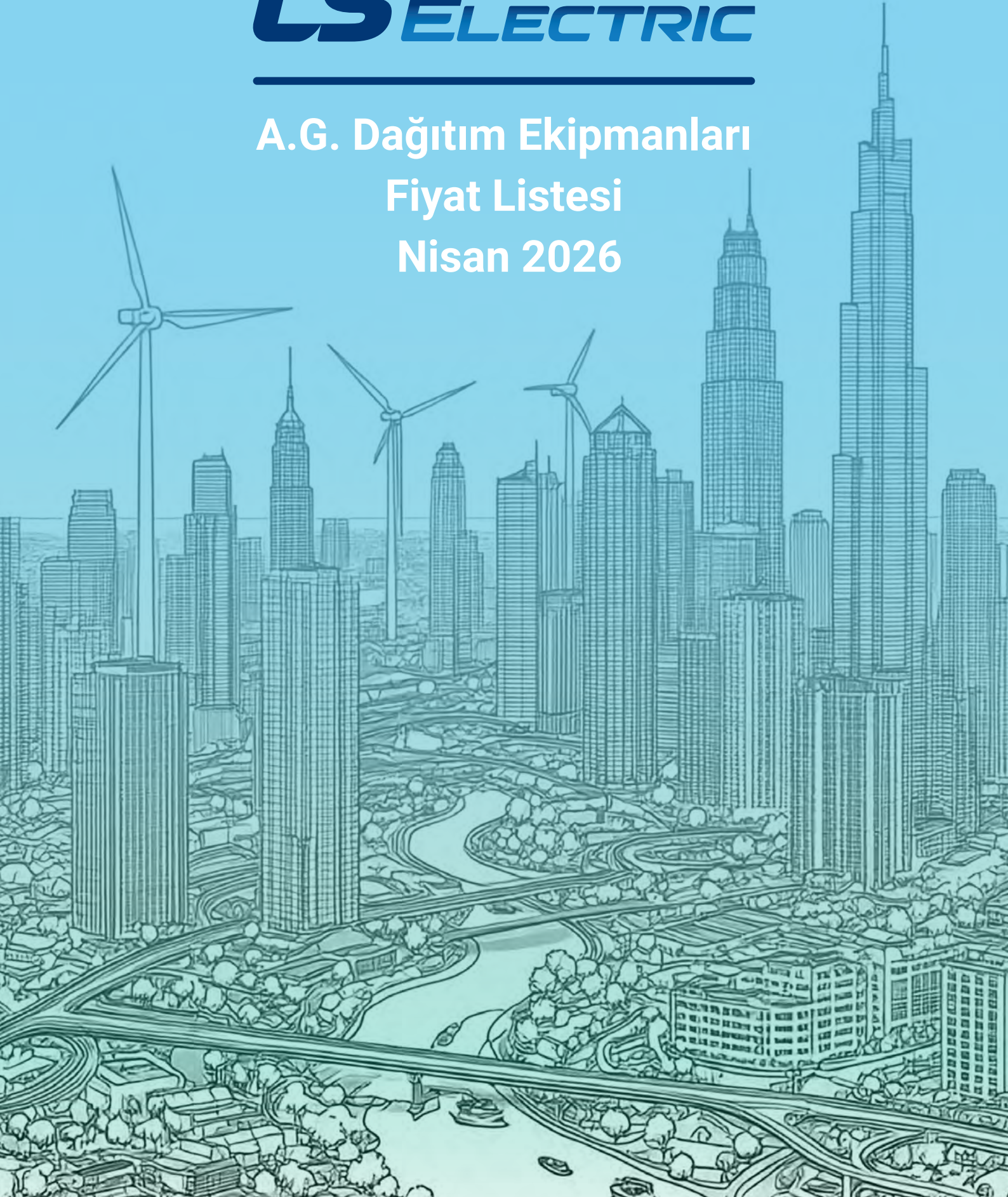

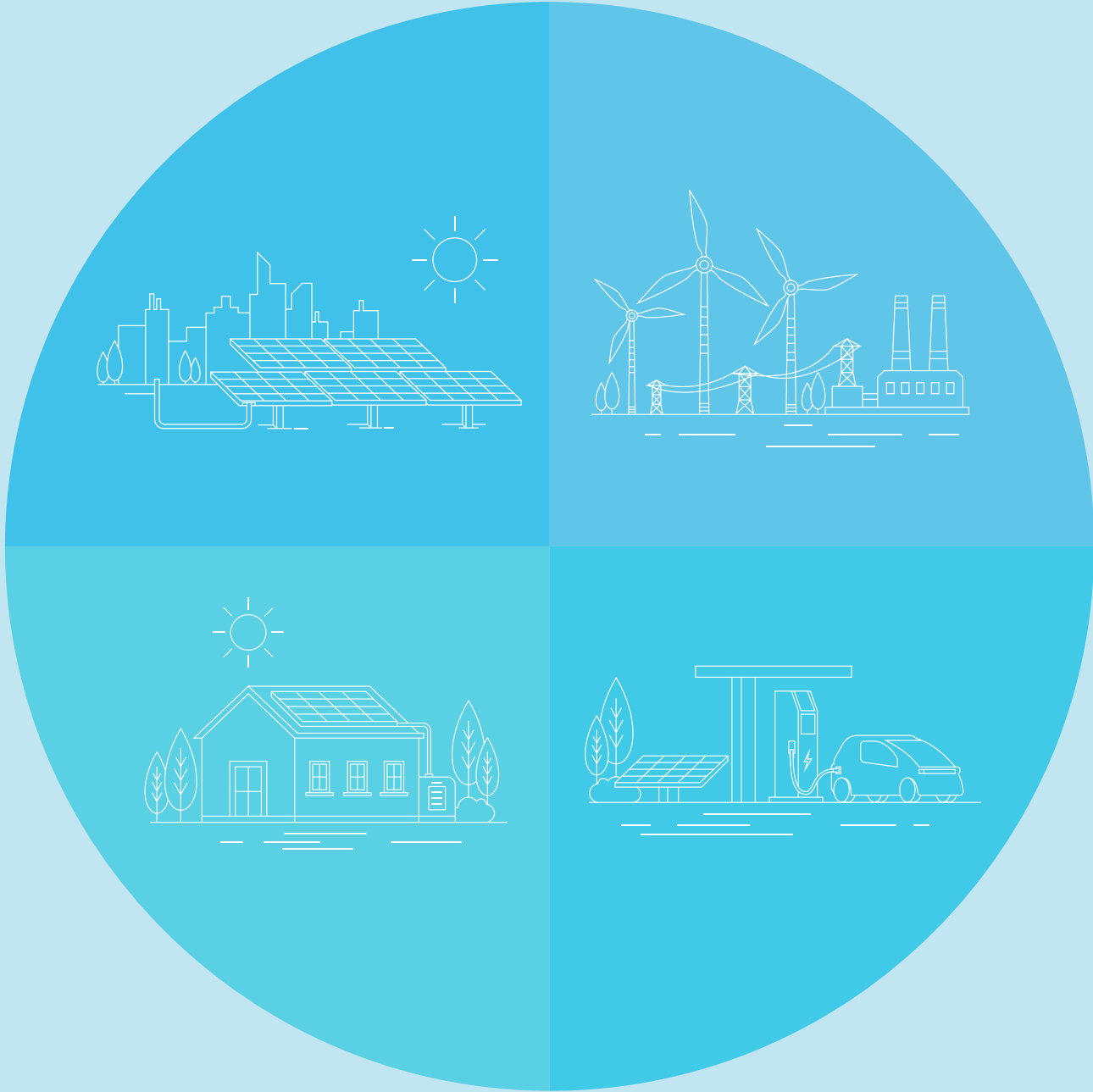

# İçindekiler

---

➤ Otomatik Sigorta ve Kaçak Akım Koruma Şalterleri	7
➤ Sessiz Kontaktörler, Darbe Akım Anahtarları	19
➤ Motor Koruma Grubumuz	21
-Metasol Serisi Manyetik Kontaktörler	23
-Mini Kontaktörler	29
-Motor Koruma Şalteri	31
-Tesol serisi Manyetik Kontaktörler	34
➤ Dağıtım Grubu Çözümleri	37
-Metasol Serisi Kompakt Tip Şalterler	40
-Susol Serisi Kompakt Şalterler	47
➤ Açık Tip Şalterler	59
-Susol Compact Serisi Açık Tip Şalterler	60
-Metasol Serisi Açık Tip Şalterler	64
➤ Solar Uygulamalar İçin Devre Kesici Çözümleri	71

---

# Global Lokasyonlar



● Yönetim Merkezi	Anyang	● Denizaşırı Satış İştirakleri	Amsterdam (Netherlands), Dubai (UAE), Tokyo (Japan), Chicago (US), Istanbul (Turkey), Jakarta (Indonesia), Madrid (Spain)
● Seul Ofis	Yongsan	● Denizaşırı Şubeler	Shanghai (China), Beijing (China), Guangzhou (China), Qingdao (China), Nanjing (China), Chengdu (China), Shenyang (China), Tokyo (Japan), Hanoi (Vietnam), Ho Chi Minh (Vietnam), Moscow (Russia), Bangkok (Thailand), Santa Fe Springs (US), Singapore (Singapore), Bengaluru (India), Verona (Italy), Bastrop Campus (US)
● Yerel Ofisler	Cheongju, Cheonan, Busan	● Denizaşırı Ar-Ge Merkezleri	Wuxi (China)
● Yerel Ar-Ge Merkezleri	R&D Campus (Anyang), Electric Power R&D Center (Cheongju), Power Testing & Technology Institute (Cheongju), Automation R&D Center (Cheonan), HVDC R&D Center (Busan)		
● Denizaşırı Holding Kuruluşları	Shanghai (China), Chicago (US)		
● Denizaşırı Üretim İştirakleri	Wuxi (China), Dalian (China), Hanoi (Vietnam), Charlotte (US), Enoch (US), Istanbul (Turkey)		

LS Grup, Elektrik Dağıtım, Endüstriyel Otomasyon, Makine ve Enerji konularında faaliyet gösteren Merkezi Güney Kore'de bulunan bir holdingdir. Büyüyen iş hacmi neticesinde, müşterilerine daha iyi hizmet sunabilmek için 2003 yılında LG Grup'tan ayrılarak bağımsız bir yapıya bürünmüştür.



## LS GROUP

ÇALIŞAN SAYISI : 24.000

BAĞLI KURULUŞLAR : 132

SATIŞ : 20.2 MİLYAR USD

FAALİYET KARI : 788 MİLYON USD

\*2024 Finansal değerleri

## LS ELECTRIC

ÇALIŞAN SAYISI : 3.112

SATIŞ : 3.3 MİLYAR USD

FAALİYET KARI : 268 MİLYON USD

\*2024 Finansal değerleri

# ÜRÜN AİLESİ LS Elektrik enerjinin yeni çağında akıllı güç ve otomasyon

**EMS**  
Energy Management System

**SCADA**  
Supervisory Control And Data Acquisition

**DMS**  
Distribution Management System

**DCS**  
Distribution Control System

## Akıllı Güç Çözümleri

### Sistemler

#### Güneş Enerji Sistemleri



#### Enerji Depolama Sistemleri (ESS)



#### Raylı Sistemler



#### Yüksek Gerilim DC Sistemleri (HVDC)



#### Esnek AC İletim Sistemleri (FACTS)



#### Modüler Dağıtım İstasyonları



#### Gaz İzoleli Şalt Sistemleri (GIS)

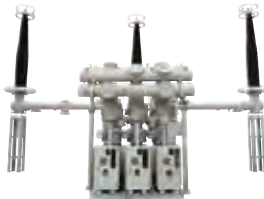

#### Trafo lar



Güç

Kuru

Yağlı

#### Panolar / Busbar



YG Pano Sistemleri



AG Pano Sistemleri



RMU



Yıldırım Koruma Sistemleri



Busbar

### Koruma / Ölçüm / Gösterge

#### Koruma



GIPAM 115

GIPAM 3000

X-GIPAM

#### Ölçüm



GIMAC 1000  
(New GIMAC-i)

GIMAC-II Plus

GIMAC-V

GIMAC-B

#### Gösterge



#### Motor Koruma Röleleri (EMPR)



GMP

DMPi

IMP

MMP

#### Data Toplama Cihazları



Cloud Service

Operation Service

Gateway

M LINK

E TAG

Ürünler

# sistemlerinde toplam çözümler sunar



## Akıllı Güç Çözümleri

### Açık Gerilim

Parafıdr  
(SPD)



Din Tipi

Otomatik Sigortalar/ Kaçak  
Akım Koruma Şalterleri



MCB

CP

Kontaktör / Termik Röleler



Metasol Contactor

Soft Starter

Kompakt Tip Şalterler  
(MCCB/ELCB)



Metasol MCCB/ELCB

Susol MCCB

Susol MCCB  
(New PI)

RCD

Açık Tip Şalterler (ACB)



Metasol ACB

Susol ACB



Susol Compact ACB



Susol ACB (New PI)

DC Dağıtım Ekipmanları



### Orta Gerilim

Vakum Kesiciler  
(VCB)



Susol VCB

Vakum Kontaktörler



Susol VCB

HV Ayırıcılar



LBS/ASS



Power Fuse



ALTS



GLBS/SLBS

## Akıllı Otomasyon Çözümleri

### Akıllı Fabrikalar



SCADA



HMI



PLC



Sürücüler



AG Sürücüler

YG Sürücüler

Servo Sistemler



Redüktörler



# LS ELECTRIC TÜRKİYE ALÇAK GERİLİM ÜRÜN AİLEMİZ



Otomatik Sigortalar & Kaçak Akım  
Koruma Şalterleri



Motor Koruma Grubu Çözümleri



Dağıtım Grubu Çözümleri

**Beklentinin  
Ötesinde**

TM

## Otomatik Sigorta ve Kaçak Akım Koruma Şalterleri



**Yeni L Serisi Otomatik Sigortalar ve  
Kaçak Akım Koruma Şalterleri**



**BKJ-BKH Serisi Otomatik Sigortalar ve  
Kaçak Akım Koruma Şalterleri**

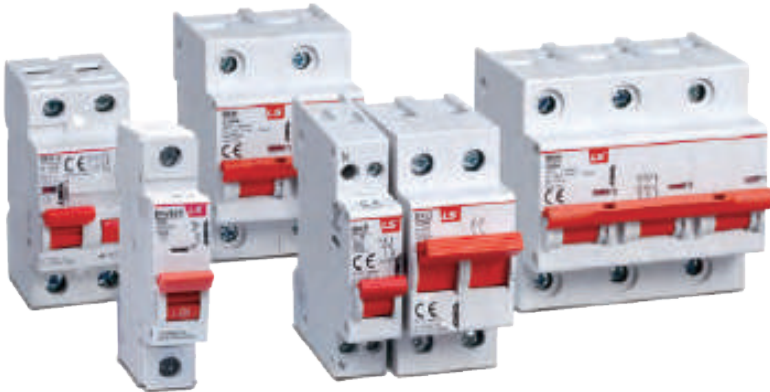

**LS** ELECTRIC

# L Serisi Otomatik Sigortalar ve Kaçak Akım Devre Kesicileri



## Gelişmiş İzolasyon

Eklenebilir yalıtım bariyeri sayesinde daha güçlü bir izolasyon sağlayın.



9mm  
daha ince

9mm 18mm

## Şık Tasarım ve Kompakt Yapı

LA100H 100A MCB (1P'ye göre), 18 mm genişliğindedir ve mevcut üründen 9 mm daha küçüktür.

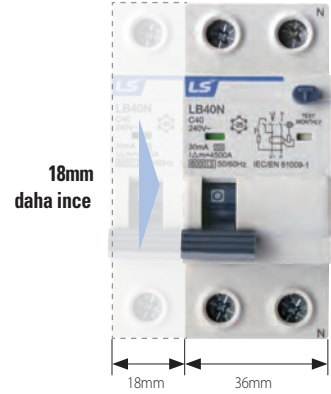

18mm  
daha ince

18mm 36mm

LB40N/LB40H RCBO (1P+N'ye göre), MCB+RCD kombinasyonundan 18 mm daha küçüktür ve 36 mm genişliğindedir.



## Kullanıcı Dostu Gösterge

Dahili Gösterge sayesinde devre kesicinin açık/kapalı konumunu kolayca doğrulayın.



## Aynı Boyut, Yüksek Performans

4.5kA'dan 15kA'ya kadar yüksek performans değerleri, aynı kompakt boyutta.



## Geniş Ürün Yelpazesi

Uygulamalarınıza özel olarak tasarlanmış farklı toprak kaçağı koruma çözümleri arasından seçim yapabilirsiniz.

\*AC Tipi

\*A Tipi

\*Zaman Gecikmeli (AC(S) / A(S) Tipi)\*

# Ürün Kodu Oluşturma

## MCB / RCBO / RCCB









LA	63	H	-	1P	B	63
Tip	Akım Çerçevesi(AF)	Kesme Kapasitesi	Özel Fonksiyon	Kutup Sayısı	Açma Eğrisi	Anma Akımı
LS MCB	32	E 4.5kA	Blank Tekli giriş	1P	B	1, 2, 3, 4, 6, 10, 13, 16, 20, 25, 32, 40, 50, 63, 80, 100, 125A
	40	N 6kA	d Çoklu giriş	1P+N	C	
	63	H 10kA	DC DC	2P	D	
	100	L 15kA	P Plug-in	3P		
	125	D Switch disconnectors		3P+N		
				4P		

LB	63	N	-	1P+N	B	63	30mA	AC type
Tip	Akım Çerçevesi(AF)	Kesme Kapasitesi	Özel Fonksiyon	Kutup Sayısı	Açma Eğrisi	Anma Akımı	Toprak Hatası Hassasiyeti	Toprak Hatası Koruma Sınıfı
LS RCBO	32	N 6kA	Blank Tekli giriş	1P+N	B	1, 2, 3, 4, 6, 10, 13, 16, 20, 25, 32, 40, 50, 63, 80, 100, 125A	10mA	AC type
	40	H 10kA	d Çoklu giriş	2P	C		30mA	A type
	50		B B-type	3P+N	D		50mA	B type
	63		N 18mm 1P+N	4P			100mA	
			W Kablolu				300mA	
			4 Sadece 4 Kutuplu					









LC	63	N	-	1P+N	63	30mA	AC type
Tip	Akım Çerçevesi(AF)	Kesme Kapasitesi(Inc)	Özel Fonksiyon	Kutup Sayısı	Açma Eğrisi	Toprak Hatası Hassasiyeti	Toprak Hatası Koruma Sınıfı
LS RCCB	63	N 6kA	Blank Tekli giriş	1P+N	16, 25, 32, 40, 50, 63, 80, 100A	30mA	AC type
	80	H 10kA	d Çoklu giriş	3P+N		100mA	A type
	100		B B-type			300mA	AC(S) type
			R N fazı sağ tarafta				A(S) type
							B type

LA/LB/LC	AX			
Tip	Ürün			
L-Series	AX	Yardımcı Kontakt	BB	Busbar
	AL	Alarm Kontakt	EC	Sonlandırma Başlığı
	U/OVT	UVT/OVT	BC	Busbar Başlığı
	SHT	Şönt	HL	Kol kilidi
	MOP	Motor Operatörü		









## B Eğrisi, 6 kA 230-400 VAC

BKJ63N B Serisi	Model	Kod No.	In	Model	Kod No.	LA63N B Serisi	Kutu Adedi	Liste Fiyatı (\$)
	<b>BKJ63N 1P</b>							
	BKJ63N 1P B1	06112360	1A	LA63N 1P B1	90710001		12	6,00
	BKJ63N 1P B2	06112361	2A	LA63N 1P B2	90710002		12	6,00
	BKJ63N 1P B3	06112362	3A	LA63N 1P B3	90710003		12	6,00
	BKJ63N 1P B4	06112363	4A	LA63N 1P B4	90710004		12	6,00
	BKJ63N 1P B6	06112364	6A	LA63N 1P B6	90710005		12	5,70
	BKJ63N 1P B10	06112365	10A	LA63N 1P B10	90710006		12	5,70
	BKJ63N 1P B16	06112367	16A	LA63N 1P B16	90710008		12	5,70
	BKJ63N 1P B20	06112368	20A	LA63N 1P B20	90710009		12	5,70
	BKJ63N 1P B25	06112369	25A	LA63N 1P B25	90710010		12	5,70
	BKJ63N 1P B32	06112370	32A	LA63N 1P B32	90710011		12	5,70
	BKJ63N 1P B40	06112371	40A	LA63N 1P B40	90710012		12	6,70
	BKJ63N 1P B50	06112372	50A	LA63N 1P B50	90710013		12	6,70
	BKJ63N 1P B63	06112373	63A	LA63N 1P B63	90710014		12	6,70
	<b>BKJ63N 2P</b>							
	BKJ63N 2P B1	06122633	1A	LA63N 2P B1	90710085		6	13,50
	BKJ63N 2P B2	06122634	2A	LA63N 2P B2	90710086		6	13,50
	BKJ63N 2P B3	06122635	3A	LA63N 2P B3	90710087		6	13,50
	BKJ63N 2P B4	06122636	4A	LA63N 2P B4	90710088		6	13,50
	BKJ63N 2P B6	06122637	6A	LA63N 2P B6	90710089		6	12,90
	BKJ63N 2P B10	06122638	10A	LA63N 2P B10	90710090		6	12,90
	BKJ63N 2P B16	06122640	16A	LA63N 2P B16	90710092		6	12,90
	BKJ63N 2P B20	06122641	20A	LA63N 2P B20	90710093		6	12,90
	BKJ63N 2P B25	06122642	25A	LA63N 2P B25	90710094		6	12,90
	BKJ63N 2P B32	06122643	32A	LA63N 2P B32	90710095		6	12,90
	BKJ63N 2P B40	06122644	40A	LA63N 2P B40	90710096		6	13,70
	BKJ63N 2P B50	06122645	50A	LA63N 2P B50	90710097		6	13,70
	BKJ63N 2P B63	06122646	63A	LA63N 2P B63	90710098		6	13,70
	<b>BKJ63N 3P</b>							
	BKJ63N 3P B1	06131171	1A	LA63N 3P B1	90710127		4	20,30
	BKJ63N 3P B2	06131172	2A	LA63N 3P B2	90710128		4	20,30
	BKJ63N 3P B3	06131173	3A	LA63N 3P B3	90710129		4	20,30
	BKJ63N 3P B4	06131174	4A	LA63N 3P B4	90710130		4	20,30
	BKJ63N 3P B6	06131175	6A	LA63N 3P B6	90710131		4	20,00
	BKJ63N 3P B10	06131176	10A	LA63N 3P B10	90710132		4	20,00
	BKJ63N 3P B16	06131178	16A	LA63N 3P B16	90710134		4	20,00
	BKJ63N 3P B20	06131179	20A	LA63N 3P B20	90710135		4	20,00
	BKJ63N 3P B25	06131180	25A	LA63N 3P B25	90710136		4	20,00
	BKJ63N 3P B32	06131181	32A	LA63N 3P B32	90710137		4	20,00
	BKJ63N 3P B40	06131182	40A	LA63N 3P B40	90710138		4	21,50
	BKJ63N 3P B50	06131183	50A	LA63N 3P B50	90710139		4	21,50
	BKJ63N 3P B63	06131184	63A	LA63N 3P B63	90710140		4	21,50
	<b>BKJ63N 4P</b>							
	BKJ63N 4P B1	06141994	1A	LA63N 4P B1	90700211		3	27,40
	BKJ63N 4P B2	06141995	2A	LA63N 4P B2	90700212		3	27,40
	BKJ63N 4P B3	06141996	3A	LA63N 4P B3	90700213		3	27,40
	BKJ63N 4P B4	06141997	4A	LA63N 4P B4	90700214		3	27,40
	BKJ63N 4P B6	06141998	6A	LA63N 4P B6	90700215		3	26,30
	BKJ63N 4P B10	06141999	10A	LA63N 4P B10	90700216		3	26,30
	BKJ63N 4P B16	06142001	16A	LA63N 4P B16	90700218		3	26,30
	BKJ63N 4P B20	06142002	20A	LA63N 4P B20	90700219		3	26,30
	BKJ63N 4P B25	06142003	25A	LA63N 4P B25	90700220		3	26,30
	BKJ63N 4P B32	06142004	32A	LA63N 4P B32	90700221		3	26,30
	BKJ63N 4P B40	06142005	40A	LA63N 4P B40	90700222		3	31,90
	BKJ63N 4P B50	06142006	50A	LA63N 4P B50	90700223		3	31,90
	BKJ63N 4P B63	06142007	63A	LA63N 4P B63	90700224		3	31,90





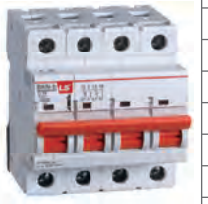



## C Eğrisi, 6 kA 230-400 VAC

BKJ63N C Serisi	Model	Kod No.	In	Model	Kod No.	LA63N C Serisi	Kutu Adedi	Liste Fiyatı (\$)
	<b>BKJ63N 1P</b>							
	BKJ63N 1P C1	06112374	1A	LA63N 1P C1	90710015		12	6,00
	BKJ63N 1P C2	06112375	2A	LA63N 1P C2	90710016		12	6,00
	BKJ63N 1P C3	06112376	3A	LA63N 1P C3	90710017		12	6,00
	BKJ63N 1P C4	06112377	4A	LA63N 1P C4	90710018		12	6,00
	BKJ63N 1P C6	06112378	6A	LA63N 1P C6	90710019		12	5,70
	BKJ63N 1P C10	06112379	10A	LA63N 1P C10	90710020		12	5,70
	BKJ63N 1P C16	06112381	16A	LA63N 1P C16	90710022		12	5,70
	BKJ63N 1P C20	06112382	20A	LA63N 1P C20	90710023		12	5,70
	BKJ63N 1P C25	06112383	25A	LA63N 1P C25	90710024		12	5,70
	BKJ63N 1P C32	06112384	32A	LA63N 1P C32	90710025		12	5,70
	BKJ63N 1P C40	06112385	40A	LA63N 1P C40	90710026		12	6,70
	BKJ63N 1P C50	06112386	50A	LA63N 1P C50	90710027		12	6,70
	BKJ63N 1P C63	06112387	63A	LA63N 1P C63	90710028		12	6,70
	<b>BKJ63N 2P</b>							
	BKJ63N 2P C1	06122647	1A	LA63N 2P C1	90710099		6	13,50
	BKJ63N 2P C2	06122648	2A	LA63N 2P C2	90710100		6	13,50
	BKJ63N 2P C3	06122649	3A	LA63N 2P C3	90710101		6	13,50
	BKJ63N 2P C4	06122650	4A	LA63N 2P C4	90710102		6	13,50
	BKJ63N 2P C6	06122651	6A	LA63N 2P C6	90710103		6	13,00
	BKJ63N 2P C10	06122652	10A	LA63N 2P C10	90710104		6	13,00
	BKJ63N 2P C16	06122654	16A	LA63N 2P C16	90710106		6	13,00
	BKJ63N 2P C20	06122655	20A	LA63N 2P C20	90710107		6	13,00
	BKJ63N 2P C25	06122656	25A	LA63N 2P C25	90710108		6	13,00
	BKJ63N 2P C32	06122657	32A	LA63N 2P C32	90710109		6	13,00
	BKJ63N 2P C40	06122658	40A	LA63N 2P C40	90710110		6	13,60
	BKJ63N 2P C50	06122659	50A	LA63N 2P C50	90710111		6	13,60
	BKJ63N 2P C63	06122660	63A	LA63N 2P C63	90710112		6	13,60
	<b>BKJ63N 3P</b>							
	BKJ63N 3P C1	06131185	1A	LA63N 3P C1	90710141		4	21,10
	BKJ63N 3P C2	06131186	2A	LA63N 3P C2	90710142		4	21,10
	BKJ63N 3P C3	06131187	3A	LA63N 3P C3	90710143		4	21,10
	BKJ63N 3P C4	06131188	4A	LA63N 3P C4	90710144		4	21,10
	BKJ63N 3P C6	06131189	6A	LA63N 3P C6	90710145		4	20,00
	BKJ63N 3P C10	06131190	10A	LA63N 3P C10	90710146		4	20,00
	BKJ63N 3P C16	06131192	16A	LA63N 3P C16	90710148		4	20,00
	BKJ63N 3P C20	06131193	20A	LA63N 3P C20	90710149		4	20,00
	BKJ63N 3P C25	06131194	25A	LA63N 3P C25	90710150		4	20,00
	BKJ63N 3P C32	06131195	32A	LA63N 3P C32	90710151		4	20,00
	BKJ63N 3P C40	06131196	40A	LA63N 3P C40	90710152		4	21,40
	BKJ63N 3P C50	06131197	50A	LA63N 3P C50	90710153		4	21,40
	BKJ63N 3P C63	06131198	63A	LA63N 3P C63	90710154		4	21,40
	<b>BKJ63N 4P</b>							
	BKJ63N 4P C1	06142008	1A	LA63N 4P C1	90710225		3	27,40
	BKJ63N 4P C2	06142009	2A	LA63N 4P C2	90710226		3	27,40
	BKJ63N 4P C3	06142010	3A	LA63N 4P C3	90710227		3	27,40
	BKJ63N 4P C4	06142011	4A	LA63N 4P C4	90710228		3	27,40
	BKJ63N 4P C6	06142012	6A	LA63N 4P C6	90710229		3	26,40
	BKJ63N 4P C10	06142013	10A	LA63N 4P C10	90710230		3	26,40
	BKJ63N 4P C16	06142015	16A	LA63N 4P C16	90710232		3	26,40
	BKJ63N 4P C20	06142016	20A	LA63N 4P C20	90710233		3	26,40
	BKJ63N 4P C25	06142017	25A	LA63N 4P C25	90710234		3	26,40
	BKJ63N 4P C32	06142018	32A	LA63N 4P C32	90710235		3	26,40
	BKJ63N 4P C40	06142019	40A	LA63N 4P C40	90710236		3	32,20
	BKJ63N 4P C50	06142020	50A	LA63N 4P C50	90710237		3	32,20
	BKJ63N 4P C63	06142021	63A	LA63N 4P C63	90710238		3	32,20

## B Eğrisi, 10 kA 230-400 VAC

BKN-b Serisi	Model	Kod No.	In	Model	Kod No.	LA63H Serisi	Kutu Adedi	Liste Fiyatı (\$)
	<b>BKN-b 1P</b>					<b>LA63H 1P</b>		
	BKN-b 1P B1	06111258	1A	LA63H 1P B1	90730001		12	10,20
	BKN-b 1P B2	06111259	2A	LA63H 1P B2	90730002		12	10,20
	BKN-b 1P B3	06111260	3A	LA63H 1P B3	90730003		12	10,20
	BKN-b 1P B4	06111261	4A	LA63H 1P B4	90730004		12	10,20
	BKN-b 1P B6	06111262	6A	LA63H 1P B6	90730005		12	9,20
	BKN-b 1P B10	06111263	10A	LA63H 1P B10	90730006		12	9,20
	BKN-b 1P B16	06111264	16A	LA63H 1P B16	90730008		12	9,20
	BKN-b 1P B20	06111265	20A	LA63H 1P B20	90730009		12	9,20
	BKN-b 1P B25	06111266	25A	LA63H 1P B25	90730010		12	9,20
	BKN-b 1P B32	06111267	32A	LA63H 1P B32	90730011		12	9,20
	BKN-b 1P B40	06111268	40A	LA63H 1P B40	90730012		12	10,80
	BKN-b 1P B50	06111269	50A	LA63H 1P B50	90730013		12	10,80
	BKN-b 1P B63	06111270	63A	LA63H 1P B63	90730014		12	10,80
	<b>BKN-b 2P</b>						<b>LA63H 2P</b>	
	BKN-b 2P B1	06121646	1A	LA63H 2P B1	90730085		6	21,90
	BKN-b 2P B2	06121647	2A	LA63H 2P B2	90730086		6	21,90
	BKN-b 2P B3	06121648	3A	LA63H 2P B3	90730087		6	21,90
	BKN-b 2P B4	06121649	4A	LA63H 2P B4	90730088		6	21,90
	BKN-b 2P B6	06121650	6A	LA63H 2P B6	90730089		6	20,90
	BKN-b 2P B10	06121651	10A	LA63H 2P B10	90730090		6	20,90
	BKN-b 2P B16	06121652	16A	LA63H 2P B16	90730092		6	20,90
	BKN-b 2P B20	06121653	20A	LA63H 2P B20	90730093		6	20,90
	BKN-b 2P B25	06121654	25A	LA63H 2P B25	90730094		6	20,90
	BKN-b 2P B32	06121655	32A	LA63H 2P B32	90730095		6	20,90
	BKN-b 2P B40	06121656	40A	LA63H 2P B40	90730096		6	23,00
	BKN-b 2P B50	06121657	50A	LA63H 2P B50	90730097		6	23,00
	BKN-b 2P B63	06121658	63A	LA63H 2P B63	90730098		6	23,00
	<b>BKN-b 3P</b>						<b>LA63H 3P</b>	
	BKN-b 3P B1	06130735	1A	LA63H 3P B1	90730127		4	37,60
	BKN-b 3P B2	06130736	2A	LA63H 3P B2	90730128		4	37,60
	BKN-b 3P B3	06130737	3A	LA63H 3P B3	90730129		4	37,60
	BKN-b 3P B4	06130738	4A	LA63H 3P B4	90730130		4	37,60
	BKN-b 3P B6	06130739	6A	LA63H 3P B6	90730131		4	32,20
	BKN-b 3P B10	06130740	10A	LA63H 3P B10	90730132		4	32,20
	BKN-b 3P B16	06130741	16A	LA63H 3P B16	90730134		4	32,20
	BKN-b 3P B20	06130742	20A	LA63H 3P B20	90730135		4	32,20
	BKN-b 3P B25	06130743	25A	LA63H 3P B25	90730136		4	32,20
	BKN-b 3P B32	06130744	32A	LA63H 3P B32	90730137		4	32,20
	BKN-b 3P B40	06130745	40A	LA63H 3P B40	90730138		4	38,30
	BKN-b 3P B50	06130746	50A	LA63H 3P B50	90730139		4	38,30
	BKN-b 3P B63	06130747	63A	LA63H 3P B63	90730140		4	38,30
	<b>BKN-b 4P</b>						<b>LA63H 4P</b>	
	BKN-b 4P B1	06141389	1A	LA63H 4P B1	90730211		3	51,40
	BKN-b 4P B2	06141390	2A	LA63H 4P B2	90730212		3	51,40
	BKN-b 4P B3	06141391	3A	LA63H 4P B3	90730213		3	51,40
	BKN-b 4P B4	06141392	4A	LA63H 4P B4	90730214		3	51,40
	BKN-b 4P B6	06141393	6A	LA63H 4P B6	90730215		3	49,30
	BKN-b 4P B10	06141394	10A	LA63H 4P B10	90730216		3	49,30
	BKN-b 4P B16	06141395	16A	LA63H 4P B16	90730218		3	49,30
	BKN-b 4P B20	06141396	20A	LA63H 4P B20	90730219		3	49,30
	BKN-b 4P B25	06141397	25A	LA63H 4P B25	90730220		3	49,30
	BKN-b 4P B32	06141398	32A	LA63H 4P B32	90730221		3	49,30
	BKN-b 4P B40	06141399	40A	LA63H 4P B40	90730222		3	54,20
	BKN-b 4P B50	06141400	50A	LA63H 4P B50	90730223		3	54,20
	BKN-b 4P B63	06141401	63A	LA63H 4P B63	90730224		3	54,20

## C Eğrisi, 10 kA 230-400 VAC

BKN-b Serisi	Model	Kod No.	In	Model	Kod No.	LA63H Serisi	Kutu Adedi	Liste Fiyatı (\$)
<b>BKN-b 1P</b> 	BKN-b 1P C1	06111271	1A	LA63H 1P C1	90730015	<b>LA63H 1P</b> 	12	10,20
	BKN-b 1P C2	06111272	2A	LA63H 1P C2	90730016		12	10,20
	BKN-b 1P C3	06111273	3A	LA63H 1P C3	90730017		12	10,20
	BKN-b 1P C4	06111274	4A	LA63H 1P C4	90730018		12	10,20
	BKN-b 1P C6	06111275	6A	LA63H 1P C6	90730019		12	9,20
	BKN-b 1P C10	06111276	10A	LA63H 1P C10	90730020		12	9,20
	BKN-b 1P C16	06111277	16A	LA63H 1P C16	90730022		12	9,20
	BKN-b 1P C20	06111278	20A	LA63H 1P C20	90730023		12	9,20
	BKN-b 1P C25	06111279	25A	LA63H 1P C25	90730024		12	9,20
	BKN-b 1P C32	06111280	32A	LA63H 1P C32	90730025		12	9,20
	BKN-b 1P C40	06111281	40A	LA63H 1P C40	90730026		12	10,80
	BKN-b 1P C50	06111282	50A	LA63H 1P C50	90730027		12	10,80
	BKN-b 1P C63	06111283	63A	LA63H 1P C63	90730028		12	10,80
	<b>BKN-b 2P</b> 	BKN-b 2P C1	06121594	1A	LA63H 2P C1		90730099	<b>LA63H 2P</b> 
BKN-b 2P C2		06121595	2A	LA63H 2P C2	90730100	6	21,90	
BKN-b 2P C3		06121596	3A	LA63H 2P C3	90730101	6	21,90	
BKN-b 2P C4		06121597	4A	LA63H 2P C4	90730102	6	21,90	
BKN-b 2P C6		06121598	6A	LA63H 2P C6	90730103	6	20,90	
BKN-b 2P C10		06121599	10A	LA63H 2P C10	90730104	6	20,90	
BKN-b 2P C16		06121600	16A	LA63H 2P C16	90730106	6	20,90	
BKN-b 2P C20		06121601	20A	LA63H 2P C20	90730107	6	20,90	
BKN-b 2P C25		06121602	25A	LA63H 2P C25	90730108	6	20,90	
BKN-b 2P C32		06121603	32A	LA63H 2P C32	90730109	6	20,90	
BKN-b 2P C40		06121604	40A	LA63H 2P C40	90730110	6	23,00	
BKN-b 2P C50		06121605	50A	LA63H 2P C50	90730111	6	23,00	
BKN-b 2P C63		06121606	63A	LA63H 2P C63	90730112	6	23,00	
<b>BKN-b 3P</b> 		BKN-b 3P C1	06130709	1A	LA63H 3P C1	90730141	<b>LA63H 3P</b> 	
	BKN-b 3P C2	06130710	2A	LA63H 3P C2	90730142	4		37,60
	BKN-b 3P C3	06130711	3A	LA63H 3P C3	90730143	4		37,60
	BKN-b 3P C4	06130712	4A	LA63H 3P C4	90730144	4		37,60
	BKN-b 3P C6	06130713	6A	LA63H 3P C6	90730145	4		32,20
	BKN-b 3P C10	06130714	10A	LA63H 3P C10	90730146	4		32,20
	BKN-b 3P C16	06130715	16A	LA63H 3P C16	90730148	4		32,20
	BKN-b 3P C20	06130716	20A	LA63H 3P C20	90730149	4		32,20
	BKN-b 3P C25	06130717	25A	LA63H 3P C25	90730150	4		32,20
	BKN-b 3P C32	06130718	32A	LA63H 3P C32	90730151	4		32,20
	BKN-b 3P C40	06130719	40A	LA63H 3P C40	90730152	4		38,30
	BKN-b 3P C50	06130720	50A	LA63H 3P C50	90730153	4		38,30
	BKN-b 3P C63	06130721	63A	LA63H 3P C63	90730154	4		38,30
	<b>BKN-b 4P</b> 	BKN-b 4P C1	06141337	1A	LA63H 4P C1	90730225		<b>LA63H 4P</b> 
BKN-b 4P C2		06141338	2A	LA63H 4P C2	90730226	3	51,40	
BKN-b 4P C3		06141339	3A	LA63H 4P C3	90730227	3	51,40	
BKN-b 4P C4		06141340	4A	LA63H 4P C4	90730228	3	51,40	
BKN-b 4P C6		06141341	6A	LA63H 4P C6	90730229	3	49,30	
BKN-b 4P C10		06141342	10A	LA63H 4P C10	90730230	3	49,30	
BKN-b 4P C16		06141343	16A	LA63H 4P C16	90730232	3	49,30	
BKN-b 4P C20		06141344	20A	LA63H 4P C20	90730233	3	49,30	
BKN-b 4P C25		06141345	25A	LA63H 4P C25	90730234	3	49,30	
BKN-b 4P C32		06141346	32A	LA63H 4P C32	90730235	3	49,30	
BKN-b 4P C40		06141347	40A	LA63H 4P C40	90730236	3	54,20	
BKN-b 4P C50		06141348	50A	LA63H 4P C50	90730237	3	54,20	
BKN-b 4P C63		06141349	63A	LA63H 4P C63	90730238	3	54,20	









## C Eğrisi, 10 kA 230-400 VAC

BKH Serisi	Model	Kod No.	In	Model	Kod No.	LA100H Serisi	Kutu Adedi	Liste Fiyatı (\$)
<b>BKH 1P</b>	BKH 1P C80A	06111251	80A	LA100H 1P C80A (li=8In)	90780002	<b>LA100H 1P</b>	12	20,40
	BKH 1P C100A	06111252	100A	LA100H 1P C100A (li=8In)	90780003		12	20,40
	BKH 1P C125A	06111253	125A	LA125H 1P C125A (li=8In)	90790011		12	39,80
<b>BKH 2P</b>	BKH 2P C80A	06121574	80A	LA100H 2P C80A (li=8In)	90780008	<b>LA100H 2P</b>	6	41,90
	BKH 2P C100A	06121575	100A	LA100H 2P C100A (li=8In)	90780009		6	41,90
	BKH 2P C125A	06121576	125A	LA125H 2P C125A (li=8In)	90790033		6	49,40
<b>BKH 3P</b>	BKH 3P C80A	06130702	80A	LA100H 3P C80A (li=8In)	90780014	<b>LA100H 3P</b>	4	65,30
	BKH 3P C100A	06130703	100A	LA100H 3P C100A (li=8In)	90780015		4	65,30
	BKH 3P C125A	06130704	125A	LA125H 3P C125A (li=8In)	90790055		4	76,50
<b>BKH 4P</b>	BKH 4P C80A	06141313	80A	LA100H 4P C80A (li=8In)	90780020	<b>LA100H 4P</b>	3	85,80
	BKH 4P C100A	06141314	100A	LA100H 4P C100A (li=8In)	90780021		3	85,80
	BKH 4P C125A	06141315	125A	LA125H 4P C125A (li=8In)	90790077		3	121,00





## Otomatik Sigortalı Kaçak Akım Koruma Şalterleri, 6kA, AC-TYPE

RKP Serisi	Model	Kod No.	In	IΔn	Model	Kod No.	LB Serisi	Kutu Adedi	Liste Fiyatı (\$)
<b>RKP 1P+N</b>	RKP 1P+N C6A 30mA	06220151	6A	30mA	LB63N 1P+N C6 30mA	90900081	<b>LB63N 1P+N</b>	6	74,00
	RKP 1P+N C6A 300mA	06220153		300mA	LB63N 1P+N C6 300mA	90900111		6	69,60
	RKP 1P+N C10A 30mA	06220155	10A	30mA	LB63N 1P+N C10 30mA	90900082		6	74,00
	RKP 1P+N C10A 300mA	06220157		300mA	LB63N 1P+N C10 300mA	90900112		6	69,60
	RKP 1P+N C16A 30mA	06220159	16A	30mA	LB63N 1P+N C16 30mA	90900084		6	74,00
	RKP 1P+N C16A 300mA	06220161		300mA	LB63N 1P+N C16 300mA	90900114		6	69,60
	RKP 1P+N C20A 30mA	06220163	20A	30mA	LB63N 1P+N C20 30mA	90900085		6	74,00
	RKP 1P+N C20A 300mA	06220165		300mA	LB63N 1P+N C20 300mA	90900115		6	69,60
	RKP 1P+N C25A 30mA	06220167	25A	30mA	LB63N 1P+N C25 30mA	90900086		6	79,60
	RKP 1P+N C25A 300mA	06220169		300mA	LB63N 1P+N C25 300mA	90900116		6	69,60
	RKP 1P+N C32A 30mA	06220171	32A	30mA	LB63N 1P+N C32 30mA	90900087		6	79,60
	RKP 1P+N C32A 300mA	06220173		300mA	LB63N 1P+N C32 300mA	90900117		6	74,10

## AC Tipi Kaçak Akım Koruma Şalterleri, 240-415 VAC

RKN Serisi	Model	Kod No.	In	IΔn	Kesme Kapasitesi	Model	Kod No.	LC Serisi	Kutu Adedi	Liste Fiyatı (\$)
	RKN 1P+N 25A 30mA AC-	06220001	25A	30 mA	6kA	LC63N 1P+N 25A 30mA AC-	90820002		6	37,00
	RKN 1P+N 32A 30mA AC-	06220004	32A			LC63N 1P+N 32A 30mA AC-	90820003		6	37,00
	RKN 1P+N 40A 30mA AC-	06220007	40A			LC63N 1P+N 40A 30mA AC-	90820004		6	37,00
	RKN 1P+N 63A 30mA AC-	06220010	63A			LC63N 1P+N 63A 30mA AC-	90820006		6	42,00
	RKN 1P+N 25A 300mA AC-	06220003	25A	300 mA		LC63N 1P+N 25A 300mA AC-	90820014		6	37,00
	RKN 1P+N 32A 300mA AC-	06220006	32A			LC63N 1P+N 32A 300mA AC-	90820015		6	37,00
	RKN 1P+N 40A 300mA AC-	06220009	40A			LC63N 1P+N 40A 300mA AC-	90820016		6	37,00
	RKN 1P+N 63A 300mA AC-	06220012	63A			LC63N 1P+N 63A 300mA AC-	90820018		6	42,00
	RKN 3P+N 25A 30mA AC-	06240001	25A	30 mA	6kA	LC63N 3P+N 25A 30mA AC-	90820038		3	52,00
	RKN 3P+N 32A 30mA AC-	06240004	32A			LC63N 3P+N 32A 30mA AC-	90820039		3	52,00
	RKN 3P+N 40A 30mA AC-	06240007	40A			LC63N 3P+N 40A 30mA AC-	90820040		3	52,00
	RKN 3P+N 63A 30mA AC-	06240010	63A			LC63N 3P+N 63A 30mA AC-	90820042		3	56,00
	RKN 3P+N 25A 300mA AC-	06240003	25A	300 mA		LC63N 3P+N 25A 300mA AC-	90820050		3	51,00
	RKN 3P+N 32A 300mA AC-	06240006	32A			LC63N 3P+N 32A 300mA AC-	90820051		3	51,00
	RKN 3P+N 40A 300mA AC-	06240009	40A			LC63N 3P+N 40A 300mA AC-	90820052		3	51,00
	RKN 3P+N 63A 300mA AC-	06240012	63A			LC63N 3P+N 63A 300mA AC-	90820054		3	55,00
	RKN-b 1P+N 25A 30mA	06220663	25A	30 mA	10kA	LC100H 1P+N 25A 30mA	90840002		6	46,00
	RKN-b 1P+N 32A 30mA	06220666	32A			LC100H 1P+N 32A 30mA	90840003		6	46,00
	RKN-b 1P+N 40A 30mA	06220669	40A			LC100H 1P+N 40A 30mA	90840004		6	46,00
	RKN-b 1P+N 63A 30mA	06220675	63A			LC100H 1P+N 63A 30mA	90840006		6	50,00
	RKN-b 1P+N 80A 30mA	06220678	80A	300 mA		LC100H 1P+N 80A 30mA	90840007		6	60,00
	RKN-b 1P+N 100A 30mA	06220681	100A			LC100H 1P+N 100A 30mA	90840008		6	76,00
	RKN-b 1P+N 25A 300mA	06220665	25A			LC100H 1P+N 25A 300mA	90840018		3	46,00
	RKN-b 1P+N 32A 300mA	06220668	32A			LC100H 1P+N 32A 300mA	90840019		3	46,00
	RKN-b 1P+N 40A 300mA	06220671	40A	LC100H 1P+N 40A 300mA		90840020	3		46,00	
	RKN-b 1P+N 63A 300mA	06220677	63A	LC100H 1P+N 63A 300mA		90840022	3		50,00	
	RKN-b 1P+N 80A 300mA	06220680	80A	LC100H 1P+N 80A 300mA		90840023	3		60,00	
	RKN-b 1P+N 100A 300mA	06220683	100A	LC100H 1P+N 100A 300mA		90840024	3		76,00	
	RKN-b 3P+N 25A 30mA	06240094	25A	30 mA	10kA	LC100H 3P+N 25A 30mA	90840066		6	63,00
	RKN-b 3P+N 32A 30mA	06240097	32A			LC100H 3P+N 32A 30mA	90840067		6	63,00
	RKN-b 3P+N 40A 30mA	06240100	40A			LC100H 3P+N 40A 30mA	90840068		6	63,00
	RKN-b 3P+N 63A 30mA	06240106	63A			LC100H 3P+N 63A 30mA	90840070		6	68,00
	RKN-b 3P+N 80A 30mA	06240109	80A	300 mA		LC100H 3P+N 80A 30mA	90840071		6	79,00
	RKN-b 3P+N 100A 30mA	06240112	100A			LC100H 3P+N 100A 30mA	90840072		6	95,00
	RKN-b 3P+N 25A 300mA	06240096	25A			LC100H 3P+N 25A 300mA	90840082		3	63,00
	RKN-b 3P+N 32A 300mA	06240099	32A			LC100H 3P+N 32A 300mA	90840083		3	63,00
	RKN-b 3P+N 40A 300mA	06240102	40A	LC100H 3P+N 40A 300mA		90840084	3		63,00	
	RKN-b 3P+N 63A 300mA	06240105	63A	LC100H 3P+N 63A 300mA		90840086	3		68,00	
	RKN-b 3P+N 80A 300mA	06240111	80A	LC100H 3P+N 80A 300mA		90840087	3		79,00	
	RKN-b 3P+N 100A 300mA	06240114	100A	LC100H 3P+N 100A 300mA		90840088	3		95,00	

## A Tipi Kaçak Akım Koruma Şalterleri, 240-415 VAC

RKN Serisi	Model	Kod No.	In	IΔn	Kesme Kapasitesi	Model	Kod No.	LC Serisi	Kutu Adedi	Liste Fiyatı (\$)	
	<b>RKN 1P+N</b>	RKN 1P+N 25A 30mA	06220444	25A	6kA	LC63N 1P+N 25A 30mA	90820020	<b>LC63N 1P+N</b>	6	49,00	
		RKN 1P+N 32A 30mA	06220447	32A		30 mA	LC63N 1P+N 32A 30mA	90820021		6	49,00
		RKN 1P+N 40A 30mA	06220450	40A			LC63N 1P+N 40A 30mA	90820022		6	49,00
		RKN 1P+N 63A 30mA	06220453	63A			LC63N 1P+N 63A 30mA	90820024		6	52,00
		RKN 1P+N 25A 300mA	06220446	25A		300 mA	LC63N 1P+N 25A 300mA	90820032		6	50,00
		RKN 1P+N 32A 300mA	06220449	32A			LC63N 1P+N 32A 300mA	90820033		6	50,00
		RKN 1P+N 40A 300mA	06220452	40A			LC63N 1P+N 40A 300mA	90820034		6	50,00
		RKN 1P+N 63A 300mA	06220455	63A			LC63N 1P+N 63A 300mA	90820036		6	53,00
	<b>RKN 3P+N</b>	RKN 3P+N 25A 30mA	06220456	25A		6kA	LC63N 3P+N 25A 30mA	90820056	<b>LC63N 3P+N</b>	3	65,00
		RKN 3P+N 32A 30mA	06220459	32A		30 mA	LC63N 3P+N 32A 30mA	90820057		3	65,00
		RKN 3P+N 40A 30mA	06220462	40A			LC63N 3P+N 40A 30mA	90820058		3	65,00
		RKN 3P+N 63A 30mA	06220465	63A			LC63N 3P+N 63A 30mA	90820060		3	76,00
		RKN 3P+N 25A 300mA	06220458	25A		300 mA	LC63N 3P+N 25A 300mA	90820068		3	62,00
		RKN 3P+N 32A 300mA	06220461	32A			LC63N 3P+N 32A 300mA	90820069		3	62,00
		RKN 3P+N 40A 300mA	06220464	40A			LC63N 3P+N 40A 300mA	90820070		3	62,00
		RKN 3P+N 63A 300mA	06220467	63A			LC63N 3P+N 63A 300mA	90820072		3	74,00
	<b>RKN-b 1P+N</b>	RKN-b 1P+N 25A 30mA	06220749	25A	10kA	LC100H 1P+N 25A 30mA	90840034	<b>LC100H 1P+N</b>	6	58,00	
		RKN-b 1P+N 32A 30mA	06220752	32A		30 mA	LC100H 1P+N 32A 30mA	90840035		6	58,00
		RKN-b 1P+N 40A 30mA	06220755	40A			LC100H 1P+N 40A 30mA	90840036		6	58,00
		RKN-b 1P+N 63A 30mA	06220758	63A			LC100H 1P+N 63A 30mA	90840038		6	64,00
		RKN-b 1P+N 80A 30mA	06220761	80A			LC100H 1P+N 80A 30mA	90840039		6	70,40
		RKN-b 1P+N 100A 30mA	06220764	100A			LC100H 1P+N 100A 30mA	90840040		6	87,00
		RKN-b 1P+N 25A 300mA	06220751	25A		300 mA	LC100H 1P+N 25A 300mA	90840050		6	58,00
		RKN-b 1P+N 32A 300mA	06220754	32A			LC100H 1P+N 32A 300mA	90840051		6	58,00
		RKN-b 1P+N 40A 300mA	06220757	40A			LC100H 1P+N 40A 300mA	90840052		6	58,00
		RKN-b 1P+N 63A 300mA	06220760	63A			LC100H 1P+N 63A 300mA	90840054		6	64,00
		RKN-b 1P+N 80A 300mA	06220763	80A			LC100H 1P+N 80A 300mA	90840055		6	70,40
		RKN-b 1P+N 100A 300mA	06220766	100A			LC100H 1P+N 100A 300mA	90840056		6	87,00
	<b>RKN-b 3P+N</b>	RKN-b 3P+N 25A 30mA	06240148	25A		10kA	LC100H 3P+N 25A 30mA	90840098	<b>LC100H 3P+N</b>	3	68,00
		RKN-b 3P+N 32A 30mA	06240151	32A		30 mA	LC100H 3P+N 32A 30mA	90840099		3	68,00
		RKN-b 3P+N 40A 30mA	06240154	40A			LC100H 3P+N 40A 30mA	90840100		3	68,00
		RKN-b 3P+N 63A 30mA	06240157	63A			LC100H 3P+N 63A 30mA	90840102		3	73,00
		RKN-b 3P+N 80A 30mA	06240160	80A			LC100H 3P+N 80A 30mA	90840103		3	84,00
		RKN-b 3P+N 100A 30mA	06240163	100A			LC100H 3P+N 100A 30mA	90840104		3	101,00
		RKN-b 3P+N 25A 300mA	06240150	25A		300 mA	LC100H 3P+N 25A 300mA	90840114		3	68,00
		RKN-b 3P+N 32A 300mA	06240153	32A			LC100H 3P+N 32A 300mA	90840115		3	68,00
		RKN-b 3P+N 40A 300mA	06240156	40A			LC100H 3P+N 40A 300mA	90840116		3	68,00
		RKN-b 3P+N 63A 300mA	06240159	63A			LC100H 3P+N 63A 300mA	90840118		3	73,00
		RKN-b 3P+N 80A 300mA	06240162	80A			LC100H 3P+N 80A 300mA	90840119		3	84,00
		RKN-b 3P+N 100A 300mA	06240165	100A			LC100H 3P+N 100A 300mA	90840120		3	101,00

## AC(S) Tipi Kaçak Akım Koruma Şalterleri, 240-415 VAC

In	IΔn	Model	Kod No.	Liste Fiyatı (\$)	Kutu Adedi	LC Serisi
40A	300 mA	LC100H 1P+N 40A 300mA AC(S)-TYPE	90840029LR	59,00	6	<b>LC100H 1P+N</b> 
63A		LC100H 1P+N 63A 300mA AC(S)-TYPE	90840030LR	59,00	6	
80A		LC100H 1P+N 80A 300mA AC(S)-TYPE	90840031LR	66,00	6	
100A		LC100H 1P+N 100A 300mA AC(S)-TYPE	90840032LR	72,00	6	
40A		LC100H 3P+N 40A 300mA AC(S)-TYPE	90840093LR	88,00	3	
63A		LC100H 3P+N 63A 300mA AC(S)-TYPE	90840094LR	88,00	3	
80A		LC100H 3P+N 80A 300mA AC(S)-TYPE	90840095LR	104,00	3	
100A		LC100H 3P+N 100A 300mA AC(S)-TYPE	90840096LR	105,00	3	

## A(S) Tipi Kaçak Akım Koruma Şalterleri, 240-415 VAC

In	IΔn	Model	Kod No.	Liste Fiyatı (\$)	Kutu Adedi	LC Serisi
40A	300 mA	LC100H 1P+N 40A 300mA A(S)-TYPE	90840061	60,00	6	<b>LC100H 1P+N</b> 
63A		LC100H 1P+N 63A 300mA A(S)-TYPE	90840062	67,00	6	
80A		LC100H 1P+N 80A 300mA A(S)-TYPE	90840063	67,00	6	
100A		LC100H 1P+N 100A 300mA A(S)-TYPE	90840064	80,00	6	
40A		LC100H 3P+N 40A 300mA A(S)-TYPE	90840125	90,00	3	
63A		LC100H 3P+N 63A 300mA A(S)-TYPE	90840126	90,00	3	
80A		LC100H 3P+N 80A 300mA A(S)-TYPE	90840127	105,00	3	
100A		LC100H 3P+N 100A 300mA A(S)-TYPE	90840128	105,00	3	

## Otomatik Sigorta Yardımcı Donanımları

Model	Kod No.	Model	Kod No.		Kutu Adedi	Liste Fiyatı (\$)
BKN Yardımcı Kontak	06150002	LA Yardımcı Kontak	90810001		1	14,80
BKN AL Alarm	06150004	LA Alarm	90810002		1	14,80
BKN SHUNT AC 24V (Açtırma Bobini)	06150067	LA-SHT AC/DC24V (Açtırma Bobini)	90810003		1	26,30
BKN SHUNT AC 110-415V (Açtırma Bobini)	06150068	LA-SHT AC110V~415V (Açtırma Bobini)	90810004		1	26,30
BKN OVT/UVT (Yüksek/Düşük Gerilim Bobini)	06150069	LA-U/OVT Un=230VAC (Yüksek/Düşük Gerilim Bobini)	90810005		1	50,90
MOP-BK63H AC 230V/DC 230V (Motor Mekanizması)	06410106	LA-MOP AC/DC 230V-Short Handle (Motor Mekanizması)	90810047		1	164,00
MOP-BK63H AC 230V/DC 230V (Motor Mekanizması)		LA-MOP AC/DC 230V-Long Handle (Motor Mekanizması)	90810076		1	164,00
AX-H Yardımcı Kontak	06410080	LB Yardımcı Kontak	90810011		1	14,80
AL-H Alarm	06410081	LB-Alarm	90810012		1	14,80
SHT-H DC24V (Açtırma Bobini)	06410082	LB-SHT AC/DC24V (Açtırma Bobini)	90810013		1	26,30
SHT-H AC110V~380V, DC60V~220V (Açtırma Bobini)	06410111	LB-SHT AC110V~415V (Açtırma Bobini)	90810014		1	26,30
UVT-H Un=AC110V (Düşük Gerilim Bobini)	06410083	LB-U/OVT Un=230VAC (Yüksek/Düşük Gerilim Bobini)	90810015		1	55,60
RKN-b AX Yardımcı Kontak	06150012	LC Yardımcı Kontak	90810006		1	17,70
RKN-b Alarm	06150013	LC Alarm	90810007		1	17,70
RKN-b SHUNT DC24V (R Phase)(Açtırma Bobini)	06150082	LC-SHT AC/DC24V (Açtırma Bobini)	90810008		1	26,30
RKN-b SHUNT AC 110-415V (Açtırma Bobini)	06150086	LC-SHT AC110V~415V (Açtırma Bobini)	90810009		1	26,30
RKN-b UVT/OVT (Yüksek/Düşük Gerilim Bobini)	06150083	LC-U/OVT Un=230VAC (Yüksek/Düşük Gerilim Bobini)	90810010		1	55,60

# Sessiz Kontaktörler, Darbe Akım Anahtarları



## Sessiz Kontaktörler (AC-1)

Model	Anma Akımı	Kontakt Sayısı	Kontakt Yapısı	Kutu Adeti	Sipariş Kodu	Açıklama	Liste Fiyatı(\$)	
MOC-16a	16A	2 Kontakt	2NA	8	27590013	MOC-16a AC230V 2P 2NA	22,50	
			1NA1NK	8	27590015	MOC-16a AC230V 2P 1NA1NK	22,50	
MOC-20a	25A		2NA	8	27590079	MOC-25a AC230V 2P 2NA	22,50	
			1NA1NK	8	27590081	MOC-25a AC230V 2P 1NA1NK	22,50	
MOC-32a	32A		2NA	8	27590106	MOC-32a AC230V 2P 2NA	37,80	
			1NA1NK	8	27590108	MOC-32a AC230V 2P 1NA1NK	37,80	
MOC-40a	40a		2NA	8	27590133	MOC-40a AC230V 2P 2NA	37,80	
			1NA1NK	8	27590135	MOC-40a AC230V 2P 1NA1NK	37,80	
MOC-63a	63A		2NA	8	27590160	MOC-63a AC230V 2P 2NA	44,00	
			1NA1NK	8	27590162	MOC-63a AC230V 2P 1NA1NK	44,00	
MOC-16a	16A		4 Kontakt	4NA	6	27590030	MOC-16a AC230V 4P 4NA	40,20
				2NA2NK	6	27590032	MOC-16a AC230V 4P 2NA2NK	40,20
MOC-20a	25A	4NA		6	27590096	MOC-25a AC230V 4P 4NA	40,20	
		2NA2NK		6	27590098	MOC-25a AC230V 4P 2NA2NK	40,20	
MOC-32a	32A	4NA		6	27590123	MOC-32a AC230V 4P 4NA	53,20	
		2NA2NK		6	27590125	MOC-32a AC230V 4P 2NA2NK	53,20	
MOC-40a	40a	4NA		6	27590150	MOC-40a AC230V 4P 4NA	53,20	
		2NA2NK		6	27590152	MOC-40a AC230V 4P 2NA2NK	53,20	
MOC-63a	63A	4NA		6	27590177	MOC-63a AC230V 4P 4NA	66,40	
		2NA2NK		6	27590179	MOC-63a AC230V 4P 2NA2NK	66,40	

## Sessiz Kontaktör Aksesuarları

Model	Anma Akımı	Çalışma Gerilimi	Kutu Adeti	Sipariş Kodu	Açıklama	Liste Fiyatı(\$)
MOC-AUX	16A	AC230V/DC110V	12	27610001	MOI-16/10 AC230V/DC110V 1P	9,30
MOC-AUX	16A	AC230V/DC110V	12	27610002	MOI-16/11 AC230V/DC110V 1P	9,30
MOC-spacer	16A	AC48V/DC24V	12	27610003	MOI-16/10 AC48V/DC24V 1P	2,10

## Darbe Akım Anahtarları

Model	Anma Akımı	Çalışma Gerilimi	Kutu Adeti	Sipariş Kodu	Açıklama	Liste Fiyatı(\$)
MOR-16/10	16A	AC230V/DC110V	12	27620005	MOI-16/10 AC230V/DC110V 1P	27,40
MOR-16/11	16A	AC230V/DC110V	12	27620015	MOI-16/11 AC230V/DC110V 1P	33,40
MOR-16/10	16A	AC48V/DC24V	12	27620003	MOI-16/10 AC48V/DC24V 1P	27,40
MOR-16/11	16A	AC48V/DC24V	12	27620013	MOI-16/11 AC48V/DC24V 1P	33,40

## Sessiz Kontaktörler

Auto

Manuel



MOC Model	25 Anma Akımı	a Tip	AC230V Kontrol Gerilimi	1P Kontakt	1NO1NC Kontakt Yapısı
16A	a	Auto	AC 24V	1P	1NO
20A	m	Manual	AC 110V	2P	1NC
25A			AC 230V	3P	1NO1NC
32A				4P	2NO
40A					2NC
63A					3NO
100A					3NC
					2NO2NC
					4NO
					2NO2NC
					3NO1NC
					4NC

## Darbe Akım Anahtarları



MOI Model	16 Anma Akımı	10 Kontakt Yapısı	AC230V Kontrol Gerilimi
16A	10	1NO	AC12V / DC6V
	20	2NO	AC24V / DC12V
	11	1NO1NC	AC48V / DC24V
	1C	1C/O(SPDT)	AC110V / DC48V
			AC230V / DC110V

**Beklentinin  
Ötesinde**

**Motor Koruma  
Grubumuz**

- ▶ **Metasol Serisi Manyetik Güç Kontaktörleri ve Termik Röleler**
- ▶ ▶ **Metasol Serisi Motor Koruma Şalterleri**
- ▶ ▶ ▶ **Yeni Tesol Serisi Manyetik Güç Kontaktörleri ve Termik Röleler**



**LS** *ELECTRIC*

# Akıllı ve Güvenilir Motor Kontrol Çözümleri

## Metasol

MC Serisi Manyetik  
Güç Kontaktörleri

MT Serisi  
Termik Röleleri

MC Serisi  
Aksesuarları



## Mini-MC

Mini-MC Serisi  
Güç Kontaktörleri

Mini-MC Serisi  
Aksesuarları



## Metasol MMS

Metasol Serisi  
Motor Koruma Şalterleri

Motor Koruma Şalterleri  
Yardımcı Donanımlar



## Tesol

MCT Serisi Manyetik  
Güç Kontaktörleri

MCT Serisi  
Termik Röleleri

MCT Serisi  
Aksesuarları



## 3 Kutuplu Güç Kontaktörleri (Bobin devresi 220VAC)

Model	Anma Gücü(kW) (400 VAC)	Termik Akımı (A) AC1	Termik Akımı (A) AC3	Yardımcı Kontak	Sipariş Kodu	Açıklama	Liste Fiyatı (\$)
MC-6a	3 kW	25 A	7 A	1 NA	13270007	MC-6a AC220V 50/60Hz 1a	27,40
	3 kW	25 A	7 A	1 NK	13270069	MC-6a AC220V 50/60Hz 1b	27,40
MC-9a	4 kW	25 A	9 A	1 NA	13160007	MC-9a AC220V 50/60Hz 1a	28,30
	4 kW	25 A	9 A	1 NK	13160069	MC-9a AC220V 50/60Hz 1b	28,30
MC-12a	5,5 kW	25 A	12 A	1 NA	13170007	MC-12a AC220V 50/60Hz 1a	33,00
	5,5 kW	25 A	12 A	1 NK	13170069	MC-12a AC220V 50/60Hz 1b	33,00
MC-18a	7,5 kW	32 A	18 A	1 NA	13280007	MC-18a AC220V 50/60Hz 1a	42,30
	7,5 kW	32 A	18 A	1 NK	13280069	MC-18a AC220V 50/60Hz 1b	42,30
MC-9b	4 kW	25 A	9A	1NA+1NK	13440007	MC-9b AC220V 50/60Hz 1a1b	30,30
MC-12b	5,5 kW	27 A	12A	1NA+1NK	13450007	MC-12b AC220V 50/60Hz 1a1b	33,20
MC-18b	7,5 kW	40 A	18A	1NA+1NK	13460007	MC-18b AC220V 50/60Hz 1a1b	42,70
MC-22b	11 kW	45 A	22A	1NA+1NK	13470007	MC-22b AC220V 50/60Hz 1a1b	56,10
MC-32a	15 kW	55 A	32A	1NA+1NK	13360069	MC-32a AC220V 50/60Hz 1a1b	69,20
MC-40a	18,5 kW	60 A	40A	1NA+1NK	13370069	MC-40a AC220V 50/60Hz 1a1b	95,30
MC-50a	22 kW	100 A	50A	1NA+1NK	13380069	MC-50a AC220V 50/60Hz 1a1b	125,90
MC-65a	30 kW	115 A	65A	1NA+1NK	13390069	MC-65a AC220V 50/60Hz 1a1b	144,20
MC-75a	37 kW	125 A	75A	1NA+1NK	13400069	MC-75a AC220V 50/60Hz 1a1b	173,70
MC-85a	45 kW	135 A	85A	1NA+1NK	13410069	MC-85a AC220V 50/60Hz 1a1b	207,30
MC-100a	55 kW	160 A	105A	1NA+1NK	13420069	MC-100a AC220V 50/60Hz 1a1b	268,40
MC-130a*	60 kW	200 A	130A	2NA+2NK	13620312	MC-130a AC100-240V 50/60Hz, DC100-220V 2a2b	349,20
MC-150a*	75 kW	250 A	150A	2NA+2NK	13640309	MC-150a AC100-240V 50/60Hz, DC100-220V 2a2b	427,70
MC-185a*	90 kW	300 A	185A	2NA+2NK	13660002	MC-185a AC100-240V 50/60Hz, DC100-220V 2a2b	562,10
MC-225a*	132 kW	350 A	225A	2NA+2NK	13680002	MC-225a AC100-240V 50/60Hz, DC100-220V 2a2b	651,70
MC-265a*	147 kw	400 A	265A	2NA+2NK	13690002	MC-265a AC100-240V 50/60Hz, DC100-220V 2a2b	875,70
MC-330a*	160 kW	500 A	330A	2NA+2NK	13700002	MC-330a AC100-240V 50/60Hz, DC100-220V 2a2b	953,10
MC-400a*	200 kW	520 A	400A	2NA+2NK	13710002	MC-400a AC100-240V 50/60Hz, DC100-220V 2a2b	1.099,70
MC-500a*	265 kW	700 A	500A	2NA+2NK	13720002	MC-500a AC100-240V 50/60Hz, DC100-220V 2a2b	2.195,40
MC-630a*	330 kW	900 A	630A	2NA+2NK	13730002	MC-630a AC100-240V 50/60Hz, DC100-220V 2a2b	2.317,60
MC-800a*	440 kW	1050 A	800 A	2NA+2NK	13740002	MC-800a AC100-240V 50/60Hz, DC100-220V 2a2b	3.509,20
MC-1260a*	500 kW	1260 A	815A	2NA+2NK	13740306	MC-1260a AC100-240V 50/60Hz, DC100-220V 2a2b	4.873,30
MC-1400a*	550 kW	1400 A	860A	2NA+2NK	14050001	MC-1400a AC100-240V 50/60Hz, DC100-220V 2a2b	8.771,90
MC-1700a*	700 kW	1700 A	1050A	2NA+2NK	14050002	MC-1700a AC100-240V 50/60Hz, DC100-220V 2a2b	11.500,90
MC-2100a*	900 kW	2100 A	1450A	2NA+2NK	14050003	MC-2100a AC100-240V 50/60Hz, DC100-220V 2a2b	14.619,80

## 4 Kutuplu Güç Kontaktörleri (Bobin devresi 220VAC)

Model	Anma Gücü(kW) (400 VAC1)	Anma Gücü (kW) (400VAC3)	Termik Akımı (A) AC1	Termik Akımı (A) AC3	Yardımcı Kontak	Sipariş Kodu	Açıklama	Liste Fiyatı (\$)
MC-9a/4	17 kW	4 kW	25 A	9A	-	13160129	MC-9a AC220V 50/60Hz 4P	39,40
MC-12a/4	17 kW	5,5 kW	25 A	12A	-	13170126	MC-12a AC220V 50/60Hz 4P	43,60
MC-18a/4	27 kW	7,5 kW	40 A	18A	-	13280126	MC-18a AC220V 50/60Hz 4P	58,20
MC-22b/4	27 kW	11 kW	40 A	22A	-	13470065	MC-22a AC220V 50/60Hz 4P	71,80
MC-32a/4	35 kW	15 kW	50 A	32A	-	13360188	MC-32a AC220V 50/60Hz 4P	108,30
MC-40a/4	42,5 kW	18,5 kW	60 A	40A	-	13370191	MC-40a AC220V 50/60Hz 4P	126,10
MC-50a/4	56 kW	22 kW	80A	50A	-	13380195	MC-50a AC220V 50/60Hz 4P	183,30
MC-65a/4	70 kW	30 kW	100 A	65A	-	13390192	MC-65a AC220V 50/60Hz 4P	211,80
MC-75a/4	76 kW	37 kW	110 A	75A	-	13400193	MC-75a AC220V 50/60Hz 4P	272,90
MC-85a/4	95 kW	45 kW	135 A	85A	-	13410193	MC-85a AC220V 50/60Hz 4P	297,30
MC-100a/4*	106 kW	55 kW	200 A	105A	2NA + 2NK	13420192	MC-100a AC/DC100-200V 2a2b 4P	611,00
MC-130a/4*	110 kW	60 kW	250 A	120A	2NA + 2NK	13620034	MC-130a AC/DC100-200V 2a2b 4P	611,00
MC-150a/4*	142 kW	75 kW	275 A	150A	2NA + 2NK	13640034	MC-150a AC/DC100-200V 2a2b 4P	712,80
MC-185a/4*	165 kW	90 kW	300 A	185A	2NA + 2NK	13660008	MC-185a AC/DC100-200V 2a2b 4P	773,90
MC-225a/4*	185 kW	132 kW	350 A	225A	2NA + 2NK	13680008	MC-225a AC/DC100-200V 2a2b 4P	896,10
MC-265a/4*	215 kw	147 kw	400 A	265A	2NA + 2NK	13690006	MC-265a AC/DC100-200V 2a2b 4P	1.425,60
MC-330a/4*	250 kW	160 kW	500 A	330A	2NA + 2NK	13700006	MC-330a AC/DC100-200V 2a2b 4P	1.547,80
MC-400a/4*	300 kW	200 kW	520 A	400A	2NA + 2NK	13710006	MC-400a AC/DC100-200V 2a2b 4P	1.670,00
MC-500a/4*	450 kW	265 kW	700 A	500A	2NA + 2NK	13720007	MC-500a AC/DC200V 2a2b 4P	2.767,90
MC-630a/4*	470 kW	330 kW	900 A	630A	2NA + 2NK	13730007	MC-630a AC/DC200V 2a2b 4P	2.980,70
MC-800a/4*	570 kW	440 kW	1050 A	800 A	2NA + 2NK	13740007	MC-800a AC/DC200V 2a2b 4P	4.406,40

\* Bobin devresi AC/DC beslemelidir.

## 3 Kutuplu Güç Kontaktörleri (Bobin devresi 24VAC)

Model	Anma Gücü(kW) (400 VAC)	Termik Akımı (A) AC1	Termik Akımı (A) AC3	Yardımcı Kontak	Sipariş Kodu	Açıklama	Liste Fiyatı (\$)
MC-6a	3 kW	25 A	7 A	1 NA	13270001	MC-6a AC24V 50/60Hz 1a	27,40
	3 kW	25 A	7 A	1 NK	13270063	MC-6a AC24V 50/60Hz 1b	27,40
MC-9a	4 kW	25 A	9 A	1 NA	13160016	MC-9a AC24V 50/60Hz 1a	28,30
	4 kW	25 A	9 A	1 NK	13160063	MC-9a AC24V 50/60Hz 1b	28,30
MC-12a	5,5 kW	25 A	12 A	1 NA	13170001	MC-12a AC24V 50/60Hz 1a	33,00
	5,5 kW	25 A	12 A	1 NK	13170063	MC-12a AC24V 50/60Hz 1b	33,00
MC-18a	7,5 kW	32 A	18 A	1 NA	13280001	MC-18a AC24V 50/60Hz 1a	42,30
	7,5 kW	32 A	18 A	1 NK	13280063	MC-18a AC24V 50/60Hz 1b	42,30
MC-9b	4 kW	25 A	9A	1NA+1NK	13440001	MC-9b AC24V 50/60Hz 1a1b	30,30
MC-12b	5,5 kW	27 A	12A	1NA+1NK	13450001	MC-12b AC24V 50/60Hz 1a1b	33,20
MC-18b	7,5 kW	40 A	18A	1NA+1NK	13460001	MC-18b AC24V 50/60Hz 1a1b	42,70
MC-22b	11 kW	45 A	22A	1NA+1NK	13470001	MC-22b AC24V 50/60Hz 1a1b	56,10
MC-32a	15 kW	55 A	32A	1NA+1NK	13360063	MC-32a AC24V 50/60Hz 1a1b	69,20
MC-40a	18,5 kW	60 A	40A	1NA+1NK	13370063	MC-40a AC24V 50/60Hz 1a1b	95,30
MC-50a	22 kW	100 A	50A	1NA+1NK	13380063	MC-50a AC24V 50/60Hz 1a1b	125,90
MC-65a	30 kW	115 A	65A	1NA+1NK	13390063	MC-65a AC24V 50/60Hz 1a1b	144,20
MC-75a	37 kW	125 A	75A	1NA+1NK	13400063	MC-75a AC24V 50/60Hz 1a1b	166,20
MC-85a	45 kW	135 A	85A	1NA+1NK	13410063	MC-85a AC24V 50/60Hz 1a1b	198,30
MC-100a	55 kW	160 A	105A	1NA+1NK	13420063	MC-100a AC24V 50/60Hz 1a1b	268,40
MC-130a*	60 kW	200 A	130A	2NA+2NK	13620013	MC-130a AC24V 50/60Hz 1a1b	325,40
MC-150a*	75 kW	250 A	150A	2NA+2NK	13640013	MC-150a AC24V 50/60Hz 1a1b	419,20
MC-185a*	90 kW	300 A	185A	2NA+2NK	13660003	MC-185a AC24-25V 50/60Hz, DC24V 2a2b	537,70
MC-225a*	132 kW	350 A	225A	2NA+2NK	13680003	MC-225a AC24-25V 50/60Hz, DC24V 2a2b	651,70

## 3 Kutuplu Güç Kontaktörleri (Bobin devresi DC)

Model	Anma Gücü(kW) (400 VAC)	Termik Akımı (A) AC1	Termik Akımı (A) AC3	Yardımcı Kontak	Sipariş Kodu	Açıklama	Liste Fiyatı (\$)
MC-9b/DC	4 kW	25A	9A	1NA +1NK Kontak	13441003	MC-9b DC24V 1a1b	45,70
					13441004	MC-9b DC48V 1a1b	54,00
MC-12b/DC	5,5kW	25A	12A		13451003	MC-12b DC24V 1a1b	73,50
					13451004	MC-12b DC48V 1a1b	84,80
MC-18b/DC	7,5 kW	40A	18A		13461003	MC-18b DC24V 1a1b	104,00
					13461004	MC-18b DC48V 1a1b	119,20
MC-22b/DC	11 kW	45A	22A		13471003	MC-22b DC24V 1a1b	154,40
					13471004	MC-22b DC48V 1a1b	195,20
MC-32a/DC	15 kW	55A	32A		13360115	MC-32a DC24V 1a1b	256,10
					13360116	MC-32a DC48V 1a1b	305,10
MC-40a/DC	18,5 kW	60A	40A		13370115	MC-40a DC24V 1a1b	313,30
					13370116	MC-40a DC48V 1a1b	378,40
MC-50a/DC	22 kW	100A	50A		13380115	MC-50a DC24V 1a1b	468,00
					13380116	MC-50a DC48V 1a1b	45,70
MC-65a/DC	30kW	115A	65A		13390115	MC-65a DC24V 1a1b	77,20
					13390116	MC-65a DC48V 1a1b	73,50
MC-75a/DC	37kW	125A	75A		13400115	MC-75a DC24V 1a1b	84,80
					13400116	MC-75a DC48V 1a1b	104,00
MC-85a/DC	45 kW	135A	85A		13410115	MC-85a DC24V 1a1b	119,20
					13410116	MC-85a DC48V 1a1b	154,40
MC-100a/DC	55 kW	160A	100A	13420115	MC-100a DC24V 1a1b	195,20	
				13420116	MC-100a DC48V 1a1b	256,10	
MC-130a/DC	60 kW	200A	130A	13620019	MC-130a DC24V 1a1b	305,10	
				13620020	MC-130a DC48V 1a1b	313,30	
MC-150a/DC	75 kW	250A	150A	13640019	MC-150a DC24V 1a1b	325,40	
				13640020	MC-150a DC48V 1a1b	419,20	
MC-185a*	90 kW	300A	185A	2NA + 2NK	13660003	MC-185a AC24-25V 50/60Hz, DC24V 2a2b	537,70
MC-225a*	132 kW	350A	225A	Kontak	13680003	MC-225a AC24-25V 50/60Hz, DC24V 2a2b	651,70

\* Bobin devresi AC/DC beslemelidir.

## Metasol Serisi Kontaktörler için Yardımcı Donanımlar

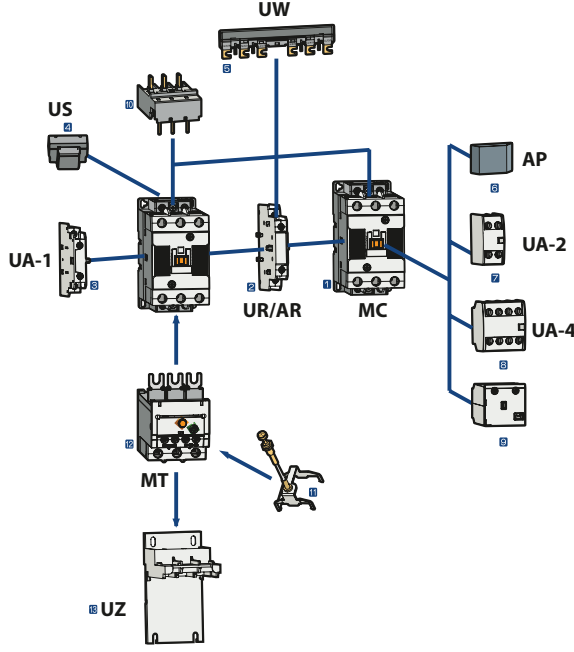

- 1 Kontaktör
- 2 Kilit Ünitesi
- 3 Yardımcı Kontaktör (yana montaj)
- 4 Varistör Ünitesi
- 5 Besleme Barası
- 6 Koruma Kapağı
- 7 Yardımcı Kontaktör (üzerine montaj - 2P)
- 8 Yardımcı Kontaktör (üzerine montaj - 4P)
- 9 Mekanik Kilit Ünitesi
- 10 Direk Bağlantı Adaptörü
- 11 Uzaktan Reset Ünitesi
- 12 Termik Röle
- 13 Raya Montaj Adaptörü

### Yardımcı Kontaktör

MR	/	4
<b>Kutup</b>		
4	4 Kutup	
6	6 Kutup	
8	8 Kutup	

### Yardımcı Kontaktörler (MR-4)

Model	Kontakt Sayısı	Çalışma Gerilimi	Yardımcı Kontakt	Sipariş Kodu	Açıklama	Liste Fiyatı (\$)
MR-4	4	DC 24V	4 NK	13891015	MR-4 DC24V 4a	47,80
			3 NK - 1 NA	13891027	MR-4 DC24V 3a1b	47,80
			2 NK - 2 NA	13891003	MR-4 DC24V 2a2b	47,80
		DC 110V	4 NK	13891020	MR-4 DC110V 4a	47,80
			3 NK - 1 NA	13891032	MR-4 DC110V 3a1b	47,80
			2 NK - 2 NA	13891008	MR-4 DC110V 2a2b	47,80
		AC 24V	4 NK	13890015	MR-4 AC24V 4a	39,50
			3 NK - 1 NA	13890029	MR-4 AC24V 3a1b	39,50
			2 NK - 2 NA	13890001	MR-4 AC24V 2a2b	39,50
		AC 220V	4 NK	13890021	MR-4 AC220VV 4a	39,50
			3 NK - 1 NA	13890035	MR-4 AC220VV 3a1b	39,50
			2 NK - 2 NA	13890007	MR-4 AC220VV 2a2b	39,50
AC 110V	4 NK	13890018	MR-4 AC110VV 4a	39,50		
	3 NK - 1 NA	13890032	MR-4 AC110VV 3a1b	39,50		
	2 NK - 2 NA	13890004	MR-4 AC110VV 2a2b	39,50		

### Yardımcı Kontakt Üniteleri

Model	Yardımcı Kontakt Sayısı	Birlikte Kullanılacağı Kontaktör		Sipariş Kodu	Montaj Şekli	Liste Fiyatı (\$)
		3P	4P			
AU-1	1NK+1NA/GMC-9-85		MC-22a/4 - 85a/4	83361611001	YANINA TAKILAN	8,60
UA-1	1NA+1NK		MC-6a/4~MC180a/4	83361634001		8,60
UA-2	2NA	MC-6a~MC-150a	MC-22a/4~MC-85a/4	83361634064	ÜZERINE TAKILAN	8,60
UA-2	1NA+1NK			83361634066		8,60
UA-2	2NK			83361634068		8,60
UA-4	4A			83361634044		13,90
UA-4	1NA+3NK			83361634046		13,90
UA-4	2NA+2NK			83361634048		13,90
UA-4	3A+1NK			83361634050		13,90
UA-4	4NK			83361634052		13,90
AU-100	1NK+1NA/GMC-100-800	MC-185a~MC-2100a	MC-100a~MC-800a/4	83361614001	YANINA TAKILAN	14,30
AU-100	2NK+2NA/GMC-100-800			83361614007		14,30
AU-100	ADD 1NK+1NA/GMC-100-800			83361614009		14,30
AU-100E	1NK+1NA/GMC-100-800			83361614016		19,20

## Yardımcı Donanımlar Kapasitör Ünitesi

	Birlikte Kullanılacağı Kontaktör	400-440V	Sipariş Kodu	Açıklama	Liste Fiyatı (\$)
	MC-12b	12.5 kVar	83631611001	AC9	31,80
MC-18b	16.7 kVar				
MC-22b	18 kVar				
MC-32a	25 kVar				
MC-40a	33.3 kVar	83631613001	AC50	44,90	
MC-50a	40 kVar	83631613009	AC75	44,90	
MC-65b	45.7 kVar				
MC-75a	54 kVar				
MC-85a	60 kVar				
MC-100a	62 kVar				

Not: Fiyatlar, Kapasitör ünitesi fiyatlarıdır. Kontaktör ayrıca satın alınmalıdır.

## Pnömatik Zaman Röleleri

	Model	Birlikte Kullanılacağı Kontaktör	Sipariş Kodu	Açıklama	Liste Fiyatı (\$)
			NOT		
UN-1N	MC-6a ~ MC-100a MC-9b ~ MC-22b	ÇEKMEDE GECIKMELI	83561634007	Pnömatik Zaman Rölesi 0,1-3 sn. 1NA+1NK	68,40
UN-2N		ÇEKMEDE GECIKMELI	83561634008	Pnömatik Zaman Rölesi 0,1-30 sn. 1NA+1NK	68,40
UN-3N		ÇEKMEDE GECIKMELI	83561634009	Pnömatik Zaman Rölesi 10-180 sn. 1NA+1NK	68,40
UN-1F		ÇEKMEDE GECIKMELI	83561634010	Pnömatik Zaman Rölesi 0,1-3 sn. 1NA+1NK	68,40
UN-3F		ÇEKMEDE GECIKMELI	83561634012	Pnömatik Zaman Rölesi 10-180 sn. 1NA+1NK	68,40

## Zaman Röleleri

	Model	Birlikte Kullanılacağı Kontaktör	Sipariş Kodu	Besleme Gerilimi	Açıklama	Liste Fiyatı (\$)
			NOT			
UT-1N	MC-6a ~ MC-150a MC-9b ~ MC-22b MR4-8	ÇEKMEDE GECIKMELI	83391634001	AC/DC 24-48V	Zaman Rölesi 1-30 saniye ayar sahası	97,00
UT-2N		ÇEKMEDE GECIKMELI	83391634002	AC 110-220V		97,00
UT-1F		ÇEKMEDE GECIKMELI	83391634003	AC/DC 24-48V		97,00
UT-2F		ÇEKMEDE GECIKMELI	83391634004	AC 110-220V		97,00

## Varistör Üniteleri

	Model	Kullanıldığı Ürün	Sipariş Kodu	Açıklama	Liste Fiyatı (\$)
	US-11	3P - MC-6a-MC-150a 3P - MC-9b-MC-22b 4P - MC-6a/4-MC-18a/4		83611634007	VARİSTÖR,US-11,AC/DC24-48V,MC-9-95
US-12			83611634008	VARİSTÖR,US-12,AC/DC100-125V,MC-9-95	11,80
US-13			83611634009	VARİSTÖR,US-13,AC/DC200-240V,MC-9-95	11,80
US-14			83611634010	VARİSTÖR,US-14,AC380-440V,MC-9-95	11,80
US-22			83611634011	VARİSTÖR,US-22,AC100-125V,MC-9-95	11,80

## İzolasyon Bariyerleri

	Model	Birlikte Kullanılacağı Kontaktör	Sipariş Kodu	Açıklama	Liste Fiyatı (\$)
			3P		
AI-180	MC-130a-400a	MC-130a-400a	83511616001	KONTAKTÖR BARIYER ÜNİTESİ AI-180,GMC-180-400	1,40
AI-600	MC-500a-1260a	MC-500a-1260a	83511618001	KONTAKTÖR BARIYER ÜNİTESİ AI-600,GMC-600-800	2,50

## Yardımcı Donanımlar

### Terminal Kapakları

	Model	Birlikte Kullanılacağı Kontaktör		Sipariş Kodu	Açıklama	Liste Fiyatı (\$)
		3P	4P			
	AP220	MC-185a-225a		64611614006	KONTAKTÖR TERMİNAL KAPAĞI GMC-180/220	9,30
	AP400	MC-265a-400a		64611614007	KONTAKTÖR TERMİNAL KAPAĞI GMC-300/400	13,00
	AP800	MC-500a-800a		64611614008	KONTAKTÖR TERMİNAL KAPAĞI GMC-600/800	20,40
	AP220		MC-185a-225a	64621616001	KONTAKTÖR TERMİNAL KAPAĞI GMC-100/220-4	10,20
	AP400		MC-265a-400a	64621617001	KONTAKTÖR TERMİNAL KAPAĞI GMC-300/400-4	15,30
	AP800		MC-500a-800a	64621618002	KONTAKTÖR TERMİNAL KAPAĞI GMC-600/800-4	25,40

### Koruma Kapakları

	Model	Birlikte Kullanılacağı Kontaktör	Sipariş Kodu	Açıklama	Liste Fiyatı (\$)
	AP-9	MC-6a-150	64611611330	KORUMA KAPAĞI MC-6a - 150a	0,40
	AP-185	MC-185a-800a	64611642069	KORUMA KAPAĞI MC-185a - 800a	1,40

### Mekanik Kilit Üniteleri

	Model	Birlikte Kullanılacağı Kontaktör		Sipariş Kodu	Açıklama	Liste Fiyatı (\$)
		3P	4P			
	UR-02	MC-6a -18a & MC-9b ~22b & MC-32a-150a	MC-9a-18a	83411634001	MEKANİK KİLİT ÜNİTESİ,UR-02,MC-9R-95R	18,40
	AR-9		MC-22a-85a	83411611003	MEKANİK KİLİT ÜNİTESİ AR-09(AYRIK)G-MC-9R-95R	18,40
	AR-180	MC-185a-400a	MC-100a-400a	83411616001	MEKANİK KİLİT ÜNİTESİ AR-180a-GMC-180R-400R	59,10
	AR-400DV	MC-265a-400a & 500a-800a		56121618011	MEKANİK KİLİT ÜNİTESİ AR-400-600V (AYRIK) 3P DİKEY	936,80
	AR-600	MC-500a-800a		56121618001	MEKANİK KİLİT ÜNİTESİ AR-600V (AYRIK) 3P YATAY	936,80
	AR-600V	MC-500a-800a		56121618002	MEKANİK KİLİT ÜNİTESİ AR-600V (AYRIK) 3P DİKEY	936,80
	AR-600/4		MC-500a-800a 4P	56121618003	MEKANİK KİLİT ÜNİTESİ AR-600(AYRIK) 4P YATAY	936,80
	AR-600/4V		MC-500a-800a 4P	56121618004	MEKANİK KİLİT ÜNİTESİ AR-600(AYRIK) 4P DİKEY	936,80

### Kutulu Tip Yolvericiler (Metal / Plastik Kutulu)\*

	Model	AC3 Akımı (IEC 60947-4-1)					Birlikte Kullanılacak	
		200-400V	380-400V	500-550V	690V	1000V	Kontaktör	Termik Röle
	MW-6a(B)	2.2kW 9A	3kW 7A	3kW 6A	3kW 4A	-	MC-6a	MT-12 (0.1-18A)
	MW-9a(B)	2.5kW 11A	4kW 9A	4kW 7A	4kW 5A	-	MC-9a	
	MW-12a(B)	3.5kW 13A	5.5kW 12A	7.5kW 12A	7.5kW 9A	-	MC-12a	
	MW-18a(B)	4.5kW 18A	7.5kW 18A	7.5kW 13A	7.5kW 9A	-	MC-18a	
	MW-9b(B)	2.5kW 11A	4kW 9A	4kW 7A	4kW 6A	-	MC-9b	MT-32 (0.1-22A)
	MW-12b(B)	3.5kW 13A	5.5kW 12A	7.5kW 12A	7.5kW 9A	-	MC-12b	
	MW-18b(B)	4.5kW 18A	7.5kW 18A	7.5kW 13A	7.5kW 9A	-	MC-18b	
	MW-22b(B)	5.5kW 22A	11kW 22A	15kW 20A	15kW 18A	-	MC-22b	
	MW-32a(B)	7.5kW 32A	15kW 32A	18.5kW 28A	18.5kW 20A	22kW 17A	MC-32a	MT-32 (0.1-40A)
	MW-40a(B)	11kW 40A	18.5kW 40A	22kW 32A	22kW 23A	22kW 17A	MC-40a	MT-63 (4-65A)
	MW-50a(B)	15kW 55A	22kW 50A	30kW 43A	30kW 28A	30kW 23A	MC-50a	
	MW-65a(B)	18.5kW 65A	30kW 65A	33kW 60A	33kW 35A	33kW 26A	MC-65a	MT-95 (7-100A)
	MW-75a(B)	22kW 75A	37kW 75A	37kW 64A	37kW 42A	37kW 28A	MC-75a	
	MW-85a(B)	25kW 85A	45kW 85A	45kW 75A	45kW 45A	45kW 33A	MC-85a	
	MW-100a(B)	30kW 105A	55kW 105A	55kW 85A	55kW 65A	45kW 33A	MC-100a	

\* Fiyat bilgisi için yetkili satış kanallarımız ile temasa geçebilirsiniz.

## Yardımcı Donanımlar

### MT Serisi Termik Röleler

Model	Birlikte Kullanılacağı Kontaktör	Termik Ayar Sahası	Anma Akımı In (A)	Sipariş Kodu	Açıklama	Liste Fiyatı (\$)
MT-12	MC-6a / MC-9a / MC-12a / MC-18a	0.1-0.16	0.14A	13190001	MT-12 0.14A 3H	33,20
		0.16-0.25	0.21A	13190002	MT-12 0.21A 3H	33,20
		0.25-0.4	0.33A	13230003	MT-12 0.33A 3K	41,50
		0.4-0.63	0.52A	13230004	MT-12 0.52A 3K	41,50
		0.63-1	0.82A	13230005	MT-12 0.82A 3K	41,50
		1-1,6	1.3A	13230006	MT-12 1.3A 3K	41,50
		1.6-2.5	2.1A	13230007	MT-12 2.1A 3K	41,50
		2,5-4	3.3A	13230008	MT-12 3.3A 3K	41,50
		4-6	5A	13230009	MT-12 5A 3K	41,50
		5-8	6.5A	13230010	MT-12 6.5A 3K	41,50
		6-9	7.5A	13230011	MT-12 7.5A 3K	41,50
		7-10	8.5A	13230012	MT-12 8.5A 3K	41,50
		9-13	11A	13230013	MT-12 11A 3K	41,50
12-18	15A	13230027	MT-12 15A 3K	41,50		
MT-32	MC-9b/ MC-12b/ MC-18b/ MC-22b/ MC-32a/ MC-40a	0.1-0.16	0.14A	12980001	MT-32 0.14A 3K	60,90
		0.16-0.25	0.21A	12980002	MT-32 0.21A 3K	60,90
		0.25-0.4	0.33A	12980003	MT-32 0.33A 3K	60,90
		0.4-0.63	0.52A	12980004	MT-32 0.52A 3K	60,90
		0.63-1	0.82A	12980005	MT-32 0.82A 3K	60,90
		1-1,6	1.3A	12980006	MT-32 1.3A 3K	60,90
		1.6-2.5	2.1A	12980007	MT-32 2.1A 3K	60,90
		2,5-4	3.3A	12980008	MT-32 3.3A 3K	60,90
		4-6	5A	12980009	MT-32 5A 3K	60,90
		5-8	6.5A	12980010	MT-32 6.5A 3K	60,90
		6-9	7.5A	12980011	MT-32 7.5A 3K	60,90
		7-10	8.5A	12980012	MT-32 8.5A 3K	60,90
		9-13	11A	12980013	MT-32 11A 3K	60,90
		12-18	15A	12980014	MT-32 15A 3K	60,90
		16-22	19A	12980015	MT-32 19A 3K	60,90
		18-25	21.5A	12980016	MT-32 21.5A 3K	60,90
22-32	27A	12980017	MT-32 27A 3K	58,10		
28-40	34A	12980020	MT-32 34A 3K	58,10		
MT-63	MC-50a-MC-65a	18-25	21,5	13100008	MT-63 21.5A 3K	93,70
		24-36	30	13100009	MT-63 30A 3K	93,70
		28-40	34	13100010	MT-63 34A 3K	93,70
		34-50	42	13100011	MT-63 42A 3K	93,70
		45-65	54	13100012	MT-63 55A 3K	93,70
MT-95	MC75a/ MC-85a/ MC-100a	54-75	65	13140010	MT-95 65A 3K	146,70
		63-85	74	13140011	MT-95 74A 3K	146,70
		70-95	83	13140012	MT-95 83A 3K	146,70
		80-100	90	13140013	MT-95 90A 3K	146,70
MT-150	MC-130a/ MC-150a	80-105	93	13750019	MT-150 93A 3K	224,00
		95-130	113	13750020	MT-150 113A 3K	224,00
		110-150	130	13750021	MT-150 130A 3K	224,00
MT-225	MC-185a/ MC-225a	120-185	153	13770014	MT-225 153A 3K	325,90
		160-240	200	13770015	MT-225 200A 3K	325,90
MT-400	MC-265a / MC-330a / MC-400a	200-330	265	13780017	MT-400 265A 3K	521,30
		260-400	350	13780018	MT-400 350A 3K	521,30

### Raya Montaj Adaptörleri (Termik Röleler İçin)

	Model	Birlikte Kullanılacağı Kontaktör	Sipariş Kodu	Açıklama	Liste Fiyatı (\$)
	UZ-32/S	MT-32 Screw	83661831001	MONTAJ ÜNİTESİ UZ-32/MT-32	9,80
	UZ-63/S	MT-63 Screw	83661832002	MONTAJ ÜNİTESİ UZ-63/MT-63	12,30
	UZ-95/S	MT-95 Screw	83661833002	MONTAJ ÜNİTESİ UZ-95/MT-95	15,50
	UZ-150/S	MT-150 Screw	83661835002	MONTAJ ÜNİTESİ UZ-150/MT-150	25,70

## 3 Kutup Güç Kontaktörleri (Bobin devresi AC)



Model	380/400V Güç (kW)	Termik Akımı (A) AC3	Termik Akımı (A) AC1	Yardımcı Kontakt	Sipariş Kodu	Açıklama	Liste Fiyatı(\$)
GMC-6M	3kW	6A	20A	1NA	12690228	AC24V 50/60HZ 1a	24,00
				1NA	12690237	AC220V 50/60HZ 1a	22,90
				1NK	12690021	AC24V 50/60HZ 1b	24,00
				1NK	12690030	AC220V 50/60HZ 1b	22,90
GMC-9M	4kW	9A	20A	1NA	12690081	AC24V 50/60HZ 1a	25,60
				1NA	12690090	AC220V 50/60HZ 1a	24,40
				1NK	12690101	AC24V 50/60HZ 1b	25,60
				1NK	12690110	AC220V 50/60HZ 1b	24,40
GMC-12M	5,5kW	12A	20A	1NA	12690167	AC24V 50/60HZ 1a	27,50
				1NA	12690176	AC220V 50/60HZ 1a	26,20
				1NK	12690188	AC24V 50/60HZ 1b	27,50
				1NK	12690197	AC220V 50/60HZ 1b	26,20
GMC-16M	7,5kW	16A	20A	1NA	12690268	AC24V 50/60HZ 1a	29,90
				1NA	12690277	AC220V 50/60HZ 1a	28,50
				1NK	12690288	AC24V 50/60HZ 1b	29,90
				1NK	12690297	AC220V 50/60HZ 1b	28,50

## 3 Kutup Güç Kontaktörleri (Bobin devresi DC)



Model	380/400V Güç (kW)	Termik Akımı (A) AC3	Termik Akımı (A) AC1	Yardımcı Kontakt	Sipariş Kodu	Açıklama	Liste Fiyatı(\$)
GMD-6M	3kW	6A	20A	1NA	12700031	DC24V 3W 1a	29,40
				1NK	12700059	DC24V 3W 1b	29,40
GMD-9M	4kW	9A	20A	1NA	12700143	DC24V 3W 1a	32,60
				1NK	12700174	DC24V 3W 1b	32,60
GMD-12M	5,5kW	12A	20A	1NA	12700258	DC24V 3W 1a	35,30
				1NK	12700286	DC24V 3W 1b	35,30
GMD-16M	7,5kW	16A	20A	1NA	12700371	DC24V 3W 1a	39,20
				1NK	12700399	DC24V 3W 1b	39,20

## Yardımcı Kontaktörler (GMR-4)

Model	Kontakt Sayısı	Çalışma Gerilimi	Yardımcı Kontakt	Sipariş Kodu	Açıklama	Liste Fiyatı(\$)
GMR-4	4	DC 24V	4 NK	12740001	GMR-4MD DC24V 3W 4a	27,50
			3 NK - 1 NA	12740003	GMR-4MD DC24V 3W 3a1b	27,50
			2 NK - 2 NA	12740005	GMR-4MD DC24V 3W 2a2b	27,50
			4 NK	12740031	GMR-4MD DC110V 3W 4a	27,50
			3 NK - 1 NA	12740032	GMR-4MD DC110V 3W 3a1b	27,50
			2 NK - 2 NA	12740033	GMR-4MD DC110V 3W 2a2b	27,50
		AC 24V	4 NK	12730035	GMR-4M AC24V 50/60Hz 4a	27,50
			3 NK - 1 NA	12730036	GMR-4M AC24V 50/60Hz 3a1b	27,50
			2 NK - 2 NA	12730037	GMR-4M AC24V 50/60Hz 2a2b	27,50
			4 NK	12730017	GMR-4M AC220V 50/60Hz 4a	27,50
			3 NK - 1 NA	12730018	GMR-4M AC220V 50/60Hz 3a1b	27,50
			2 NK - 2 NA	12730019	GMR-4M AC220V 50/60Hz 2a2b	27,50
		AC 110V	4 NK	12730011	GMR-4M AC110V 50/60Hz 4a	27,50
			3 NK - 1 NA	12730007	GMR-4M AC110V 50/60Hz 3a1b	27,50
			2 NK - 2 NA	12730032	GMR-4M AC110V 50/60Hz 2a2b	27,50

## Yardımcı Kontaktlar



Model	Kontakt Sayısı	Not	Kontakt	Sipariş Kodu	Açıklama	Liste Fiyatı(\$)	
AU-1M 10	1P	Yanına Takılan	1NO	83361621001	Yardımcı kontakt ünitesi	AU-1M,1A,	8,10
AU-1M 01			1NC	83361621002		AU-1M,1B,	8,10
AU-2M 20	2P	Yanına Takılan	2NO	83361621008		AU-2M,2A	11,20
AU-2M 11			1NO + 1NC	83361621009		AU-2M,1A,1B	11,20
AU-4M 40	4P	Üzerine Takılan	4NO	83361621003		AU-4M,4A,	17,10
AU-4M 31			3NO + 1NC	83361621004		AU-4M,3A1B,	17,10
AU-4M 22			2NO + 2NC	83361621005		AU-4M,2A2B,	17,10
AU-4M 13			1NO + 3NC	83361621006		AU-4M,1A3B,	17,10
AU-4M 04			4NC	83361621007		AU-4M,4B,	17,10

## Varistörler



Model	Kullanıldığı Kontaktör Tipi	Sipariş Kodu	Açıklama	Liste Fiyatı(\$)
AS-12M/1	GMC-6M-16M	83611621001	VARIŞTÖR,AS-12M/1,AC24-48V	14,00
AS-12M/3		83611621003	VARIŞTÖR,AS-12M/3,AC200-240V	14,00
AS-12M/4	GMD-6M-16M	83611621004	VARIŞTÖR,AS-12M/4,DC12-24V	14,00
AS-12M/7		83611621007	VARIŞTÖR,AS-12M/7,AC/DC200-250V	14,00

## Zaman Röleleri



Model	Tip	Birlikte Kullanılacağı Kontaktör	Çalışma Gerilimi	Sipariş Kodu	Açıklama	Liste Fiyatı(\$)
AT-12/1N	Çekmede	GMC-6M ~ 16M GMD-6M ~ 16M	AC/DC 24-48V	83391621001	Zaman rölesi 0.1-30 saniye ayar sahası	174,80
AT-12/2IN	Gecikmeli		AC 110-220V	83391621002		174,80
AT-12/1F	Düşmede		AC/DC 24-48V	83391621003		174,80
AT-12/2F	Gecikmeli		AC 110-220V	83391621004		174,80

## Mekanik Kilit Üniteleri



Model	Not	Sipariş Kodu	Açıklama	Liste Fiyatı(\$)
AR-12M	MEKANİK KİLİT ünitesi	83411621001	AR-12M(SEPERATE),GMC(D)-6-16MR	6,10
AR-12MW	MEKANİK KİLİT ünitesi	83411621007	AR-12MW(SEPERATE),GMC(D)-6-16MR	9,80

## Termik Röleler



Model	Kutup	Termik Ayar Sahası	Birlikte Kullanılacağı Kontaktör	Sipariş Kodu	Açıklama	Liste Fiyatı(\$)
GTK-12M	3P	0.1~0.16A	GMC / GMD 6,9,12,16 M	12710029	GTK-12M 0.14A 3H	30,00
		0.16~0.25A		12710030	GTK-12M 0.21A 3H	30,00
		0.25~0.4A		12710031	GTK-12M 0.33A 3H	30,00
		0.4~0.63A		12710032	GTK-12M 0.52A 3H	30,00
		0.63~1.0A		12710033	GTK-12M 0.82A 3H	30,00
		1.0~1.6A		12710034	GTK-12M 1.3A 3H	30,00
		1.6~2.5A		12710035	GTK-12M 2.1A 3H	30,00
		2.5~4A		12710036	GTK-12M 3.3A 3H	30,00
		4~6A		12710037	GTK-12M 5A 3H	30,00
		5~8A		12710038	GTK-12M 6.5A 3H	30,00
		6~9A		12710039	GTK-12M 7.5A 3H	30,00
		7~10A		12710040	GTK-12M 8.5A 3H	30,00
		9~13A		12710041	GTK-12M 11A 3H	30,00
		12~16A		12710042	GTK-12M 14A 3H	30,00

## Raya Montaj Adaptörü



Model	Birlikte kullanılacağı kontaktör	Sipariş Kodu	Açıklama	Liste Fiyatı(\$)
AZ-12H	GTK-12M	83661821002	Raya montaj adaptörü AZ-12H	15,50

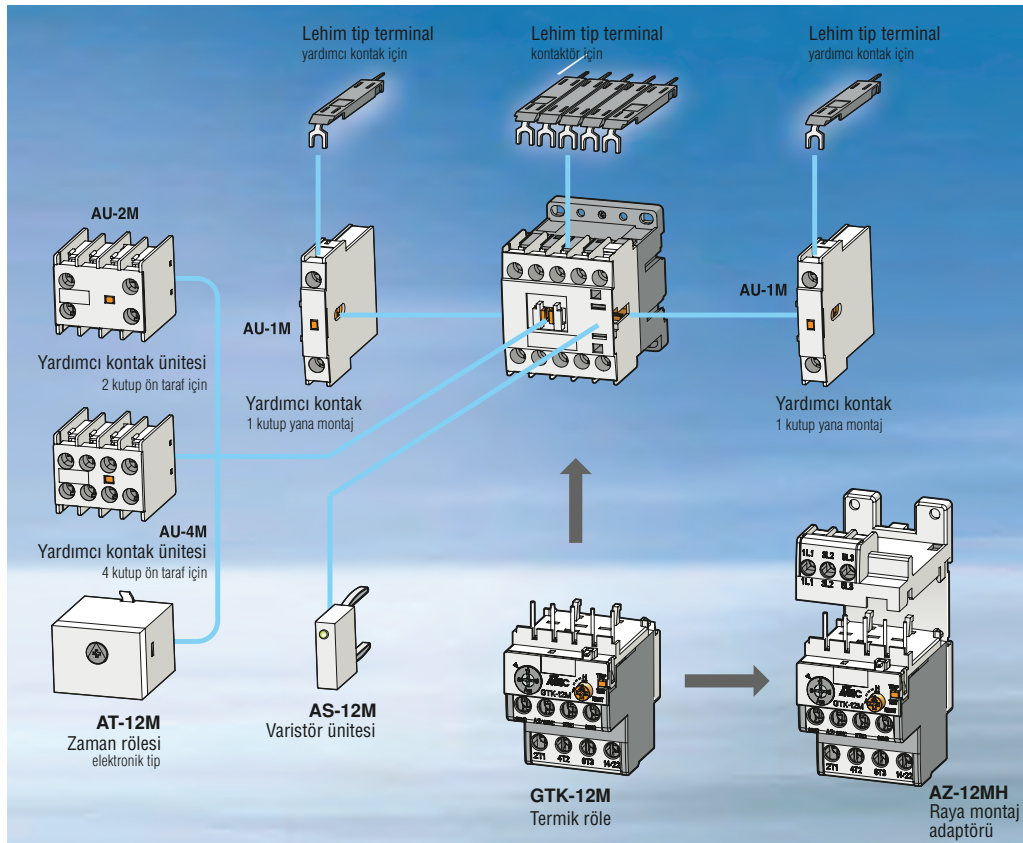

**Metasol** *Meta Solution*

# Motor Koruma Şalteri



MMS-32D

MMS-32S

MMS-32H

MMS-63S

**LS** **ELECTRIC**

## MMS Serisi Motor Koruma Şalterleri (Standart Kesme Kapasitesi)

Model	Anma Gücü (kW) AC-3 400V	Anma Akımı (A)	Termik Ayar Sahası (A)	Kesme Kapasitesi Icu (kA) 400V	Sipariş Kodu	Açıklama	Liste Fiyatı (\$)
	-	0,16	0.1-0.16	100	07050033	MMS-32S 0.16A	61,00
	0,06	0,25	0.16-0.25	100	07050034	MMS-32S 0.25A	61,00
	0,09	0,4	0.25-0.4	100	07050035	MMS-32S 0.4A	61,00
	0,12	0,63	0.4-0.63	100	07050036	MMS-32S 0.63A	61,00
	0,25	1	0.63-1	100	07050037	MMS-32S 1A	60,50
	0,55	1,6	1-1.6	100	07050038	MMS-32S 1.6A	60,50
	0,75	2,5	1.6-2.5	100	07050039	MMS-32S 2.5A	60,50
	1,5	4	2.5-4	100	07050040	MMS-32S 4A	60,50
	2,2	6	4-6	100	07050041	MMS-32S 6A	60,50
	3	8	5-8	100	07050042	MMS-32S 8A	60,50
	4	10	6-10	50	07050043	MMS-32S 10A	60,50
	5,5	13	9-13	50	07050044	MMS-32S 13A	65,10
	7,5	17	11-17	20	07050045	MMS-32S 17A	65,10
	7,5	22	14-22	15	07050046	MMS-32S 22A	65,10
	11	26	18-26	15	07050047	MMS-32S 26A	65,10
15	32	22-32	15	07050048	MMS-32S 32A	65,10	
	18,5	40	28-40	10	07050089	MMS-32S 40A	65,10
	22	50	34-50	25	07060008	MMS-63S 50A	176,70
	30	63	45-63	25	07060009	MMS-63S 63A	176,70
	37	75	55-75	50	07070008	MMS-100S 75A	334,90
	45	90	70-90	50	07070009	MMS-100S 90A	334,90
	45	100	80-100	50	07070010	MMS-100S 100A	334,90

## MMS-H/Hi Serisi Motor Koruma Şalterleri (Yüksek Kesme Kapasitesi)

Model	Anma Gücü (kW) AC-3 400V	Anma Akımı (A)	Termik Ayar Sahası (A)	Kesme Kapasitesi Icu (kA) 400V	Sipariş Kodu	Açıklama	Liste Fiyatı (\$)
	4	10	6-10	50	07050011	MMS-32H 10A	74,40
	5,5	13	9-13	50	07050012	MMS-32H 13A	79,10
	7,5	17	11-17	20	07050013	MMS-32H 17A	79,10
	7,5	22	14-22	15	07050014	MMS-32H 22A	79,10
	11	26	18-26	15	07050015	MMS-32H 26A	79,10
	15	32	22-32	15	07050016	MMS-32H 32A	79,10
	18,5	40	28-40	10	07060016	MMS-63H 40A	190,70
	22	50	34-50	25	07060017	MMS-63H 50A	195,40
	30	63	45-63	25	07060018	MMS-63H 63A	195,40
	37	75	55-75	50	07070018	MMS-100H 75A	372,10
	45	90	70-90	50	07070019	MMS-100H 90A	372,10
	45	100	80-100	50	07070020	MMS-100H 100A	372,10

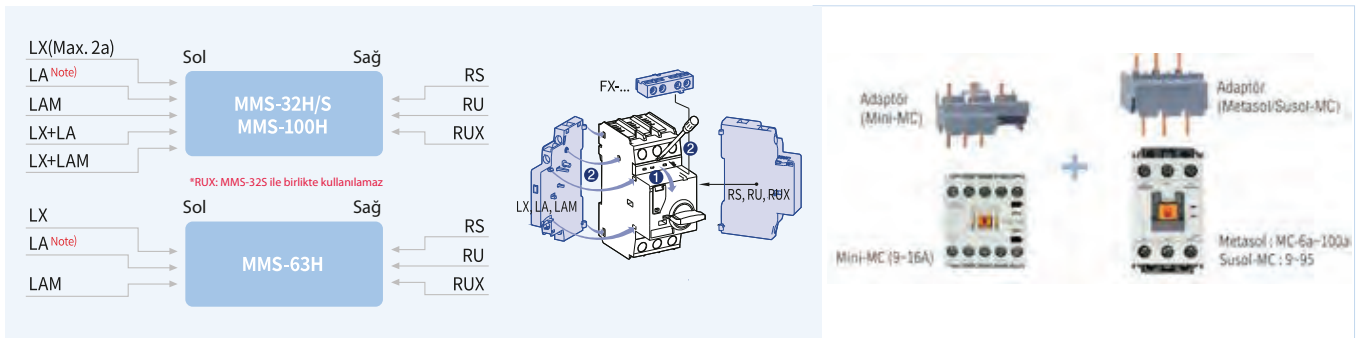

### Koruma Kutusu

MMS koruma kutusu toz ve patlayıcı ortamlarda kullanılmak üzere koruyucu özellikli olarak tasarlanmıştır. Çimento ve pamuk fabrikaları gibi toz yoğun, ya da rafineri gübre ve kaplama tesisleri gibi yanıcı ve patlayıcı gazların bulunduğu ortamlarda optimum çözümler sunar.

Uygulanabilen Model : MMS-32  
İşletme Sıcaklığı : -20 ~ + 60 OC  
Koruma Sınıfı : IP65  
Yalıtım Malzemesi : Plastik (ABS)  
Sertifikalar : CE, UL

Tip	Ölçü	Sipariş Kodu	Açıklama	Liste Fiyatı (\$)
Koruma Kutusu	EPH32-65S	53911941001	KORUMA KUTUSU,EPH32-65S	37,20

## Yardımcı Donanımlar

### Yardımcı ve Alarm Kontakları

Tip	Montaj Şekli	Yardımcı Kontakt	Sipariş Kodu	Açıklama		Liste Fiyatı (\$)
FX20 FX11 FX02	Üste Takılabilen	2NA	83361941111	Yardımcı Kontakt	FX,2NA	14,00
		1NA1NK	83361941112		FX,1NA1NK	14,00
		2NK	83361941113		FX,2NK	14,00
LX20 LX11 LX02	Yana Takılabilen	2NA	83361941114		LX,2NA	18,60
		1NA1NK	83361941115		LX,1NA1NK	18,60
		2NK	83361941116		LX,2NK	18,60
LA20 LA11 LA02	Alarm Kontaklı Tüm Arızalar	2NA	83011941111	Alarm Kontaklı	LA,2NA	23,30
1NA1NK		83011941112	LA,1NA1NK		23,30	
2NK		83011941113	LA,2NK		23,30	
LAM20 LAM11 LAM02	Alarm Kontaklı Manyetik Arızalar	2NA	83011941114		LAM,2NA	23,30
1NA1NK		83011941115	LAM,1NA1NK		23,30	
2NK		83011941116	LAM,2NK		23,30	

### Açtırma ve Düşük Gerilim Bobinleri

Tip	Tanım	Sipariş Kodu	Açıklama	Liste Fiyatı (\$)
RS230 RS400	Açtırma Bobini	70911941113	SHUNT,RS,AC220V~230V 50 Hz/AC240V~260V 60 Hz	37,20
		70911941115	SHUNT,RS,AC380V~400V 50 Hz/AC440V~460V 60 Hz	37,20
RU230 RU400	Düşük Gerilim Bobini	83211941113	T,UVT,RU,AC220V~230V 50Hz/AC240V~260V 60Hz	37,20
		83211941115	T,UVT,RU,AC380V~400V 50Hz/AC440V~460V 60Hz	37,20
RUX230 RUX400	Düşük Gerilim Açtırma Bobini + Alarm Switch	83211941133	T,UVT,RUX,AC220V~230V 50Hz/AC240V~260V 60Hz	41,90
		83211941135	T,UVT,RUX,AC380V~400V 50Hz/AC440V~460V 60Hz	41,90

### Kurma Kolları

Tip	Ölçü	Sipariş Kodu	Açıklama	Liste Fiyatı (\$)	
MEH-32	115 mm	83111912111	KURMA KOLU	MEH-32,115 mm	41,90
MEH-32	315 mm	83111912114		MEH-32,315 mm	46,50
MEH-63	115 mm	83111912112		MEH-63,115 mm	41,90
MEH-63	315 mm	83111912115		MEH-63,315 mm	46,50
MEH-100	115 mm	83111912113		MEH-100,115 mm	41,90
MEH-100	315 mm	83111912116		MEH-100,315 mm	46,50

### Direk Bağlantı Montaj Üniteleri

Tip	Ölçü	Sipariş Kodu	Açıklama	Liste Fiyatı (\$)	
MU-45	45 mm	83661941111	MONTAJ ÜNİTESİ	MU-45	14,00
MU-55	55 mm	83661941112		MU-55	23,30
MU-70	70 mm	83661941113		MU-70	27,90

### Kontaktör MMS Adaptörleri

Adaptör	Birleştirdiği Ürünler	Sipariş Kodu	Açıklama	Liste Fiyatı (\$)		
DA-16SA	MMS-32S+GMC-6M-16M	73311941111	MU45	AC,DA-16SA	9,30	
DA-16SD	MMS-32S+GMD-6M-16M	73311941112		AC,DA-16SD	9,30	
DA-16HA	MMS-32H+GMC-6M-16M	73311941113		AC,DA-16HA	9,30	
DA-16HD	MMS-32H+GMD-6M-16M	73311941114		AC,DA-16HD	9,30	
DA-18SA	MMS-32S+MC-6a-18a AC	73311634131		AC,DA-18SA	14,00	
DA-18SD	MMS-32S+MC-6a-18a DC	73311634133		AC,DA-18SD	14,00	
DA-18HA	MMS-32H/HI+MC-6a-18a AC	73311634132		AC,DA-18HA	14,00	
DA-18HD	MMS-32H/HI+MC-6a-18a DC	73311634134		AC,DA-18HD	14,00	
DA-22SA	MMS-32S+MC-9b-22b AC	73311634135		AC,DA-22SA	14,00	
DA-22SD	MMS-32S+MC-9b-22b DC	73311634137		AC,DA-22SD	14,00	
DA-22HA	MMS-32H/HI+MC-9b-22b AC	73311634136		AC,DA-22HA	14,00	
DA-22HD	MMS-32H/HI+MC-9b-22b DC	73311634138		AC,DA-22HD	14,00	
DA-32SA	MMS-32S+MC-32a,40a AC	73311634121		AC,DA-32SA	18,60	
DA-32SD	MMS-32S+MC-32a,40a DC	73311634123		AC,DA-32SD	18,60	
DA-32HA	MMS-32H/HI+MC-32a,40a AC	73311634122		AC,DA-32HA	18,60	
DA-32HD	MMS-32H/HI+MC-32a,40a DC	73311634124		AC,DA-32HD	18,60	
DA-63A	MMS-63S/H/HI+MC-50a,65a AC LUG	73311634125		MU55	AC,DA-63A	18,60
DA-63D	MMS-63S/H/HI+MC-50a,65a DC LUG	73311634126			AC,DA-63D	18,60
DA-95A	MMS-100S/H/HI+MC-75a-100a AC LUG	73311634127	MU70	AC,DA-95A	27,90	
DA-95D	MMS-100S/H/HI+MC-75a-100a DC LUG	73311634128		AC,DA-95D	27,90	

## Manyetik Güç Kontaktörleri ve Termik Röleler

YENİ



### Kontaktör

MCT

-

9

AC220V

50/60Hz

1a

Tesol Serisi MC

Anma Akımı

9	9A
12	12A

Bobin Voltajı

AC24V	AC24V
AC36V	AC36V

Bobin Frekansı

50/60Hz	50/60Hz
Blank	DC and Free voltage

Yardımcı Kontakt

1a	1a
1b	1b
1a1b	1a1b
2a2b	2a2b
3a3b	3a3b
4a4b	4a4b

800	800A
-----	------

AC/DC200V	AC/DC200V
-----------	-----------

### Thermal Overload Relay

MTT

-

32

0.14A

Tesol Serisi Termik Röle

Anma Akımı

32	Max 32A
40	Max 40A

Ayar Akımı

0.14A	0.1-0.16A
-------	-----------

800	Max 800A
-----	----------

660A	520~800A
------	----------

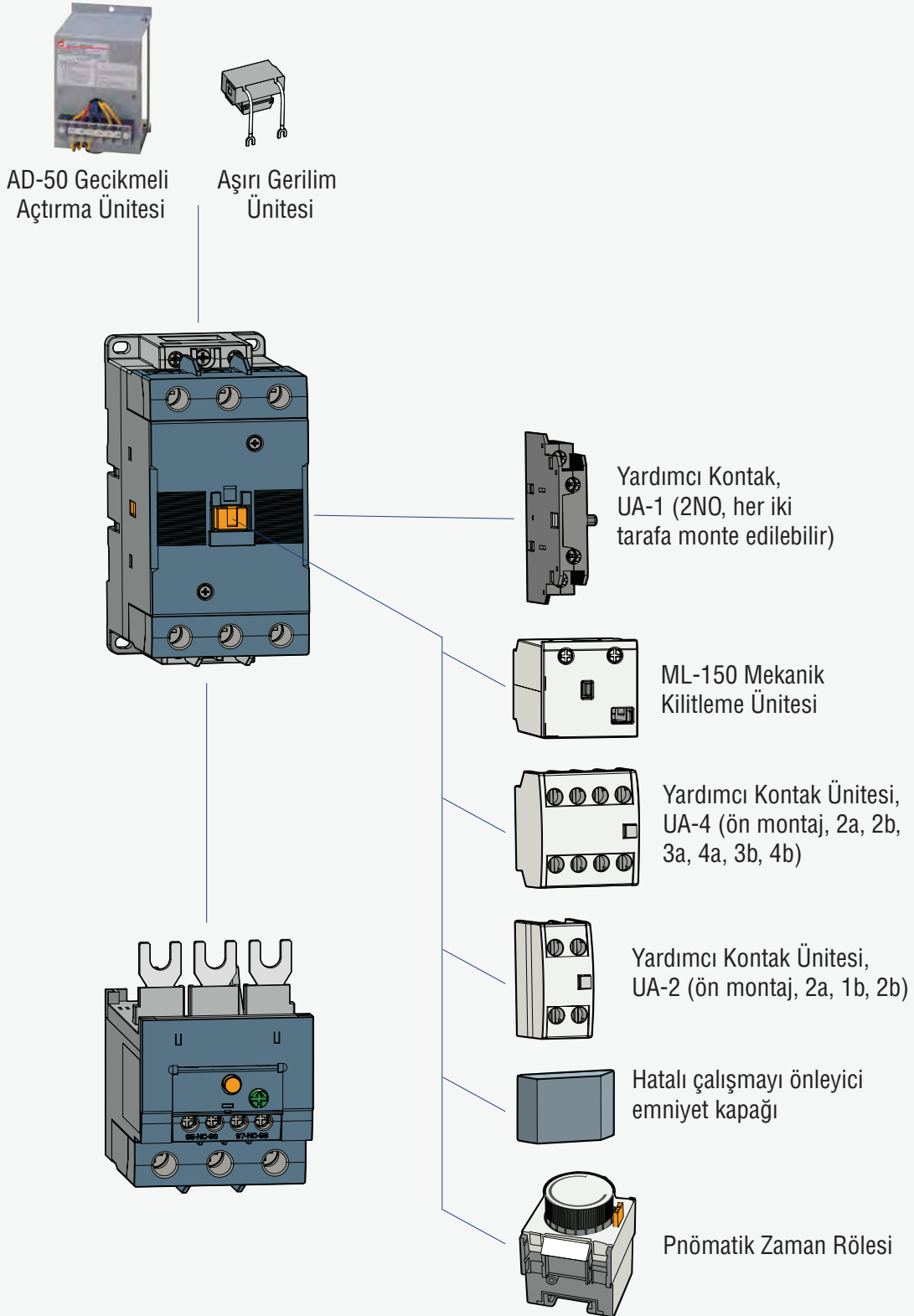

\*Uyumlu aksesuarlar kasa ölçülerine göre değişiklik gösterebilmektedir.  
Lütfen satış kanallarımızla iletişime geçiniz.

## TESOL Serisi Manyetik Güç Kontaktörleri Kasa Ölçüleri:

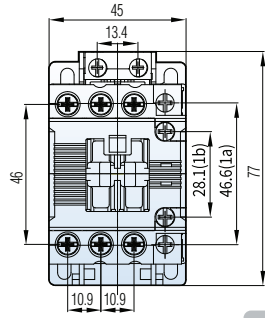

MCT-9-32

1a, 1b, 1a1b

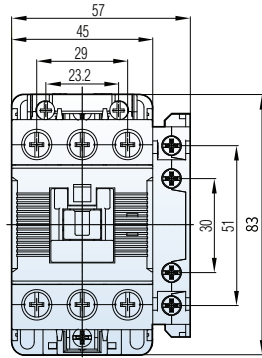
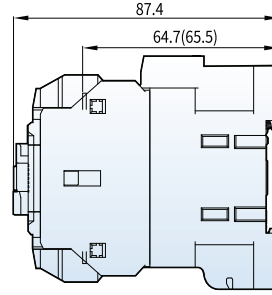

MCT-40

1a1b

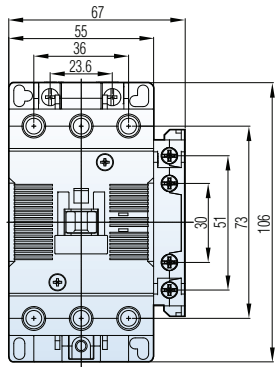
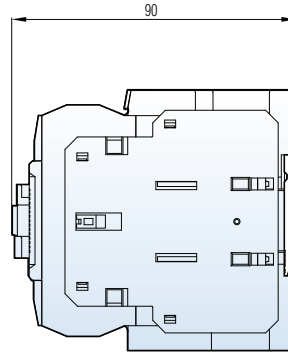

MCT-50-65

1a1b

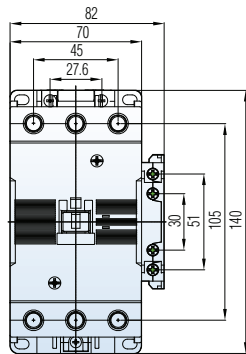
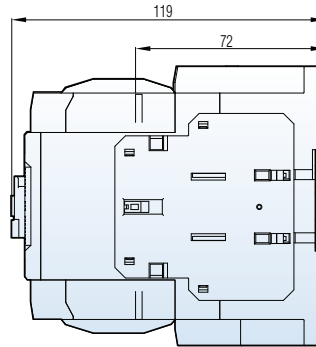

MCT-75-100

1a1b

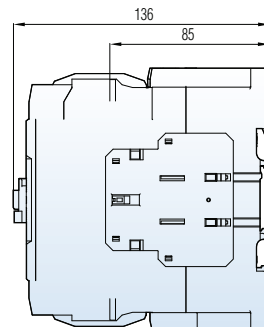

**Beklentinin  
Ötesinde**

**TM Dağıtım Grubu  
Çözümleri**

**Metasol Serisi Kompakt Tip Şalterler**

**TSE Serisi Kompakt Tip Şalterler**

**Yeni**

**Susol Serisi Serisi Kompakt Tip Şalterler**

**Susol/Metasol Serisi Açık Tip Şalterler**

**Susol Compact Serisi Açık Tip Şalterler**





**LS ELECTRIC**

## DAĞITIM GRUBU ÜRÜN YELPAZEMİZ

	ALT DAĞITIM	
Devre Kesici Tipi	Kompakt Tip Şalter	Kompakt Tip Şalter
Anma Akımı,In	3~1200A	16~630A
Kesme Kapasitesi,Icu	10~85kA	37~85kA
Servis Kesme Kapasitesi(% Icu),Ics	100%	100%
Kategori	A	A
Açtırma Üniteleri	FTU: Sabit Termik, Sabit Manyetik	ATU: Ayarlanabilir Termik, Ayarlanabilir Manyetik FMU: Ayarlanabilir Termik, Sabit Manyetik
Uyumlu Standartlar	IEC 60947-2	IEC 60947-2
Ürün Görseli		
Ürün Grubu	<b>Metasol</b>	<b>TSE</b>
Ürün Serisi	ABH, ABN, ABS	TSE

**ANA DAĞITIM**

Kompakt Tip Şalter	Açık Tip Şalter	Açık Tip Şalter
16~800A	1000~1600A	630~6300A
37~150kA	50~150kA	65~150kA
100%	75~100%	100%
A	A, B	B
ATU: Ayarlanabilir Termik, Ayarlanabilir Manyetik FMU: Ayarlanabilir Termik, Sabit Manyetik MTU: Ayarlanabilir Manyetik, Sabit Termik DSU: Yük Ayırıcı ETS: Standart Tip Elektronik(L,S,I) ETM: Çok Fonksiyonlu Tip Elektronik(L,S,I,G)	Lütfen Sayfa 68'i inceleyiniz.	Lütfen Sayfa 68'i inceleyiniz.
IEC 60947-2, UL489	IEC 60947-2	IEC 60947-2
		
<b>Susol</b>	<b>Susol Compact</b>	<b>Susol · Metasol</b>
TE, TD, TS	AN, AH, AW	AN, AH, AS

3 Kutuplu Termik Sabit / Manyetik Sabit Tip Kompakt Şalterler (Ics=%100Icu)

Model	Anma Akımı (A)	Termik Ayar akımı (A)	Manyetik Ayar akımı (A)	Kesme Kapasitesi Icu (kA)	Sipariş Kodu	Açıklama	Liste Fiyatı(\$)
100AF	16A	Sabit	Sabit (400A)	18kA	01310077	ABN103c 16A	107,00
	20A				01310078	ABN103c 20A	107,00
	30A				01310079	ABN103c 30A	107,00
	40A	Sabit	Sabit (12In)	18kA	01310080	ABN103c 40A	107,00
	50A				01310081	ABN103c 50A	107,00
	60A				01310082	ABN103c 60A	107,00
	75A				01310083	ABN103c 75A	107,00
	100A				01310084	ABN103c 100A	107,00
250AF	125A	Sabit	Sabit (12In)	25kA	01370054	ABN203c 125A	191,00
	150A				01370055	ABN203c 150A	191,00
	175A				01370056	ABN203c 175A	191,00
	200A				01370057	ABN203c 200A	191,00
	225A				01370058	ABN203c 225A	205,00
	250A				01370059	ABN203c 250A	209,00
125AF	16A	Sabit	Sabit (400A)	37kA	01340001	ABS103c 15A	135,00
	20A				01340002	ABS103c 20A	135,00
	30A				01340003	ABS103c 30A	135,00
	40A	Sabit	Sabit (12In)	37kA	01340004	ABS103c 40A	135,00
	50A				01340005	ABS103c 50A	135,00
	60A				01340006	ABS103c 60A	135,00
	75A				01340007	ABS103c 75A	135,00
	100A				01340008	ABS103c 100A	135,00
	125A				01340009	ABS103c 125A	135,00
250AF	150A	Sabit	Sabit (12In)	37kA	01370003	ABS203c 150A	214,00
	175A				01370004	ABS203c 175A	233,00
	200A				01370005	ABS203c 200A	233,00
	225A				01370006	ABS203c 225A	233,00
	250A				01370007	ABS203c 250A	237,00
400AF	300A	Sabit	8-12In	37kA	01640006	ABN403c 300A	553,00
	350A				01640007	ABN403c 350A	553,00
	400A				01640008	ABN403c 400A	553,00
800AF	500A	Sabit	8-12In	37kA	01660023	ABN803c 500A	874,00
	630A				01660024	ABN803c 630A	874,00
	700A				01660003	ABN803c 700A	1.065,00
	800A				01660004	ABN803c 800A	1.065,00
50AF	15A	Sabit	Sabit (12In)	50kA	01340010	ABH53c 15A	116,00
	20A				01340011	ABH53c 20A	116,00
	30A				01340012	ABH53c 30A	116,00
	40A				01340013	ABH53c 40A	116,00
	50A				01340014	ABH53c 50A	116,00
125AF	60A	Sabit	Sabit (12In)	50kA	01340020	ABH103c 60A	177,00
	75A				01340021	ABH103c 75A	177,00
	100A				01340022	ABH103c 100A	177,00
	125A				01340023	ABH103c 125A	191,00
250AF	150A	Sabit	Sabit (12In)	50kA	01400003	ABH203c 150A	265,00
	175A				01400004	ABH203c 175A	265,00
	200A				01400005	ABH203c 200A	265,00
	225A				01400006	ABH203c 225A	265,00
	250A				01400007	ABH203c 250A	284,00
	300A				01640018	ABS403c 300A	572,00
400AF	350A	Sabit	8-12In	50kA	01640019	ABS403c 350A	572,00
	400A				01640020	ABS403c 400A	572,00
	500A				01660029	ABS803c 500A	1.047,00
800AF	630A	Sabit	8-12In	65kA	01660034	ABS803c 630A	1.047,00
	700A				01660009	ABS803c 700A	1.112,00
	800A				01660010	ABS803c 800A	1.112,00

## 4 Kutuplu Termik Sabit / Manyetik Sabit Tip Kompakt Şalterler (Ics=%100Icu)

Model	Anma Akımı (A)	Termik Ayar akımı (A)	Manyetik Ayar akımı (A)	Kesme Kapasitesi Icu (kA)	Sipariş Kodu	Açıklama	Liste Fiyatı(\$)
100AF	16A	Sabit	Sabit (400A)	18kA	01320059	ABN104c 16A	130,00
	20A				01320060	ABN104c 20A	130,00
	30A				01320061	ABN104c 30A	130,00
	40A	Sabit	Sabit (12In)	18kA	01320062	ABN104c 40A	130,00
	50A				01320063	ABN104c 50A	130,00
	60A				01320064	ABN104c 60A	130,00
	75A				01320065	ABN104c 75A	130,00
	100A				01320066	ABN104c 100A	130,00
250AF	125A	Sabit	Sabit (12In)	25kA	01380023	ABN204c 125A	219,00
	150A				01380024	ABN204c 150A	237,00
	175A				01380025	ABN204c 175A	237,00
	200A				01380026	ABN204c 200A	237,00
	225A				01380027	ABN204c 225A	237,00
	250A				01380028	ABN204c 250A	260,00
	125AF				16A	Sabit	Sabit (400A)
20A		01350002	ABS104c 20A	163,00			
30A		01350003	ABS104c 30A	163,00			
40A		Sabit	Sabit (12In)	37kA	01350004	ABS104c 40A	163,00
50A					01350005	ABS104c 50A	163,00
60A					01350006	ABS104c 60A	163,00
75A					01350007	ABS104c 75A	163,00
100A					01350008	ABS104c 100A	163,00
125A					01350009	ABS104c 125A	163,00
250AF					150A	Sabit	Sabit (12In)
	175A	01380004	ABS204c 175A	270,00			
	200A	01380005	ABS204c 200A	270,00			
	225A	01380006	ABS204c 225A	270,00			
	250A	01380007	ABS204c 250A	298,00			
	400AF	300A	Sabit	8-12In	37kA		
350A		01640011				ABN404c 350A	730,00
400A		01640012				ABN404c 400A	730,00
800AF	500A	Sabit	8-12In	37kA	01660025	ABN804c 500A	1.051,00
	630A				01660026	ABN804c 630A	1.051,00
	700A				01660005	ABN804c 700A	1.349,00
	800A				01660006	ABN804c 800A	1.349,00
50AF	15A	Sabit	Sabit (12In)	50kA	01350010	ABH54c 15A	149,00
	20A				01350011	ABH54c 20A	149,00
	30A				01350012	ABH54c 30A	149,00
	40A				01350013	ABH54c 40A	149,00
	50A				01350014	ABH54c 50A	149,00
	125AF				60A	Sabit	Sabit (12In)
75A		01350021	ABH104c 75A	205,00			
100A		01350022	ABH104c 100A	205,00			
125A		01350023	ABH104c 125A	223,00			
250AF		150A	Sabit	Sabit (12In)	50kA		
	175A	01410004				ABH204c 175A	377,00
	200A	01410005				ABH204c 200A	377,00
	225A	01410006				ABH204c 225A	377,00
	250A	01410007				ABH204c 250A	377,00
	400AF	300A				Sabit	8-12In
350A		01640023	ABS404c 350A	698,00			
400A		01640024	ABS404c 400A	698,00			
800AF	500A	Sabit	8-12In	65kA	01660035	ABS804c 500A	1.307,00
	630A				01660036	ABS804c 630A	1.307,00
	700A				01660011	ABS804c 700A	1.330,00
	800A				01660012	ABS804c 800A	1.330,00

3 Kutuplu Kompakt Tip Toprak Kaçak Akım Koruma Şalterleri ( $I_{\Delta n}=30mA$ ) ( $I_{cs}=\%100I_{cu}$ )

Model	Anma Akımı (A)	Termik Ayar akımı (A)	Manyetik Ayar akımı (A)	$I_{\Delta n}$	Kesme Kapasitesi ucu (kA)	Sipariş Kodu	Açıklama	Liste Fiyatı(\$)
125AF	20A	Sabit	Sabit (400A)	30mA	37kA	1440002	EBS103c 20A 30mA	353,00
	30A					1440003	EBS103c 30A 30mA	353,00
	40A					1440004	EBS103c 40A 30mA	353,00
	50A					1440005	EBS103c 50A 30mA	353,00
	60A		1440006			EBS103c 60A 30mA	353,00	
	75A		1440007			EBS103c 75A 30mA	353,00	
	100A		1440008			EBS103c 100A 30mA	353,00	
	125A		1440009			EBS103c 125A 30mA	353,00	
250AF	150A	Sabit	Sabit (12In)	30mA	37kA	1450017	EBS203c 150A 30mA	758,00
	175A					1450018	EBS203c 175A 30mA	758,00
	200A					1450019	EBS203c 200A 30mA	758,00
	225A					1450020	EBS203c 225A 30mA	781,00
	250A					1450021	EBS203c 250A 30mA	781,00
	250AF					250A	Sabit	Sabit (8-12In)
300A	1670018	EBS403c 300A 30mA	1.242,00					
350A	1670019	EBS403c 350A 30mA	1.242,00					
400A	1670020	EBS403c 400A 30mA	1.242,00					
800AF	500A	Sabit	Sabit (8-12In)	30mA	65kA	1690017	EBS803c 500A 30mA	2.819,00
	630A					1690018	EBS803c 630A 30mA	2.819,00
	700A					1690005	EBS803c 700A 30mA	2.819,00
	800A					1690006	EBS803c 800A 30mA	2.819,00

3 Kutuplu Kompakt Tip Toprak Kaçak Akım Koruma Şalterleri ( $I_{\Delta n}=100/200-300/500mA$ ) ( $I_{cs}=\%100I_{cu}$ )

Model	Anma Akımı (A)	Termik Ayar akımı (A)	Manyetik Ayar akımı (A)	$I_{\Delta n}$	Kesme Kapasitesi ucu (kA)	Sipariş Kodu	Açıklama	Liste Fiyatı(\$)
125AF	20A	Sabit	Sabit (400A)	100/300 500mA	37kA	1440519	EBS103c 20A 100/300/500mA	321,00
	30A					1440520	EBS103c 30A 100/300/500mA	321,00
	40A					1440521	EBS103c 40A 100/300/500mA	321,00
	50A					1440522	EBS103c 50A 100/300/500mA	321,00
	60A		1440523			EBS103c 60A 100/300/500mA	321,00	
	75A		1440524			EBS103c 75A 100/300/500mA	321,00	
	100A		1440525			EBS103c 100A 100/300/500mA	321,00	
	125A		1440526			EBS103c 125A 100/300/500mA	321,00	
250AF	150A	Sabit	Sabit (12In)	100/300 500mA	37kA	1450340	EBS203c 150A 100/300/500mA	679,00
	175A					1450341	EBS203c 175A 100/300/500mA	684,00
	200A					1450342	EBS203c 200A 100/300/500mA	693,00
	225A					1450343	EBS203c 225A 100/300/500mA	716,00
	250A					1450344	EBS203c 250A 100/300/500mA	735,00
	250AF					250A	Sabit	Sabit (8-12In)
300A	1670022	EBS403c 300A 100/200/500mA	1.358,00					
350A	1670023	EBS403c 350A 100/200/500mA	1.358,00					
400A	1670024	EBS403c 400A 100/200/500mA	1.358,00					
800AF	500A	Sabit	Sabit (8-12In)	100/200 500mA	65kA	1690019	EBS803c 500A 100/200/500mA	2.684,00
	630A					1690020	EBS803c 630A 100/200/500mA	2.684,00
	700A					1690007	EBS803c 700A 100/200/500mA	2.684,00
	800A					1690008	EBS803c 800A 100/200/500mA	2.684,00

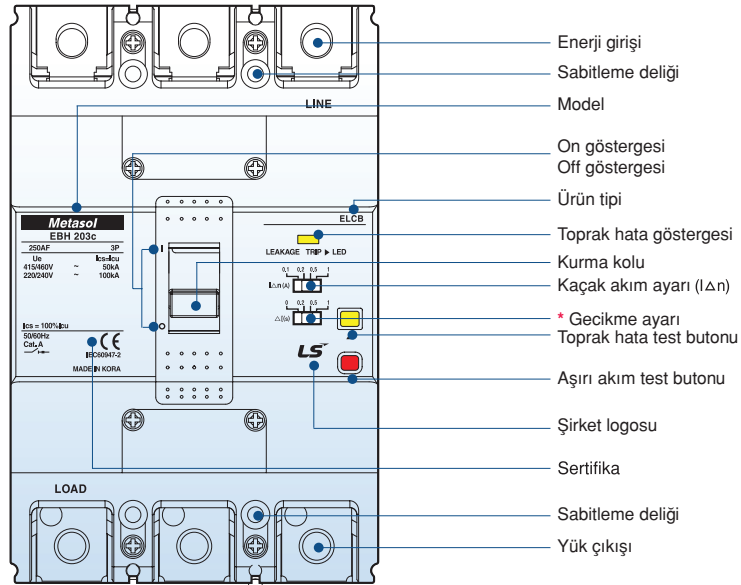

\* Fiyat listesinde yer alan ürünlerde gecikme ayarı yoktur. Gecikme ayarı olan ürün talepleriniz için yetkili satış kanallarımızla temasa geçebilirsiniz.

## 4 Kutuplu Kompakt Tip Toprak Kaçak Akım Koruma Şalterleri ( $I_{\Delta n}=30\text{mA}$ ) ( $I_{cs}=\%100I_{cu}$ )

Model	Anma Akımı (A)	Termik Ayar akımı (A)	Manyetik Ayar akımı (A)	$I_{\Delta n}$	Kesme Kapasitesi ucu (kA)	Sipariş Kodu	Açıklama	Liste Fiyatı(\$)
125AF	20A	Sabit	Sabit (400A)	30mA	37kA	01440048	EBS104c 20A 30mA	414,00
	30A					01440049	EBS104c 30A 30mA	414,00
	40A					01440050	EBS104c 40A 30mA	414,00
	50A					01440051	EBS104c 50A 30mA	414,00
	60A		Sabit (12In)			01440052	EBS104c 60A 30mA	414,00
	75A					01440053	EBS104c 75A 30mA	414,00
	100A					01440054	EBS104c 100A 30mA	414,00
	125A					01440055	EBS104c 125A 30mA	414,00
250AF	150A	Sabit	Sabit (12In)	30mA	37kA	01450045	EBS204c 150A 30mA	893,00
	175A					01450046	EBS204c 175A 30mA	893,00
	200A					01450047	EBS204c 200A 30mA	893,00
	225A					01450048	EBS204c 225A 30mA	921,00
	250A					01450049	EBS204c 250A 30mA	921,00
	400AF					250A	Sabit	Sabit (8-12In)
300A		01670026	EBS404c 300A 30mA	1.637,00				
350A		01670027	EBS404c 350A 30mA	1.637,00				
400A		01670028	EBS404c 400A 30mA	1.637,00				

## 4 Kutuplu Kompakt Tip Toprak Kaçak Akım Koruma Şalterleri ( $I_{\Delta n}=100/200-300/500\text{mA}$ ) ( $I_{cs}=\%100I_{cu}$ )

Model	Anma Akımı (A)	Termik Ayar akımı (A)	Manyetik Ayar akımı (A)	$I_{\Delta n}$	Kesme Kapasitesi ucu (kA)	Sipariş Kodu	Açıklama	Liste Fiyatı(\$)
125AF	20A	Sabit	Sabit (400A)	100/300 500mA	37kA	01440542	EBS104c 20A 100/300/500mA	409,00
	30A					01440543	EBS104c 30A 100/300/500mA	409,00
	40A					01440544	EBS104c 40A 100/300/500mA	409,00
	50A					01440545	EBS104c 50A 100/300/500mA	409,00
	60A		Sabit (12In)			01440546	EBS104c 60A 100/300/500mA	409,00
	75A					01440547	EBS104c 75A 100/300/500mA	409,00
	100A					01440548	EBS104c 100A 100/300/500mA	409,00
	125A					01440549	EBS104c 125A 100/300/500mA	414,00
	250AF					150A	Sabit	Sabit (12In)
175A		01450348	EBS204c 175A 100/300/500mA	907,00				
200A		01450349	EBS204c 200A 100/300/500mA	907,00				
225A		01450350	EBS204c 225A 100/300/500mA	935,00				
250A		01450351	EBS204c 250A 100/300/500mA	935,00				
400AF		250A	Sabit	Sabit (8-12In)	100/200 500mA	50kA		
	300A	01670030					EBS404c 300A 100/200/500mA	1.558,00
	350A	01670031					EBS404c 350A 100/200/500mA	1.558,00
	400A	01670032					EBS404c 400A 100/200/500mA	1.558,00

Metasol ELCB							
AF Type	30AF	50AF	60AF	100AF	125AF	250AF	
EBN		EBN50c 14kA	EBN60c 14kA	EBN100c 18kA		EBN250c 26kA	
EBS	EBS30c 14kA	EBS50c 18kA	EBS60c 18kA		EBS125c 37kA	EBS250c 37kA	
EBH		EBH50c 50kA			EBH125c 50kA	EBH250c 50kA	
AF Type	400AF	630AF	800AF				
EBN	EBN400c 37kA	EBN630c 37kA	EBN800c 37kA				
EBS	EBS400c 50kA	EBS630c 65kA	EBS800c 65kA				
EBH	EBH400c 65kA						
EBL	EBL400c 85kA	EBL630c 85kA	EBL800c 85kA				

Fiyat listemizde yer almayan ürünlerimiz için yetkili satış kanallarımız ile temasa geçebilirsiniz.

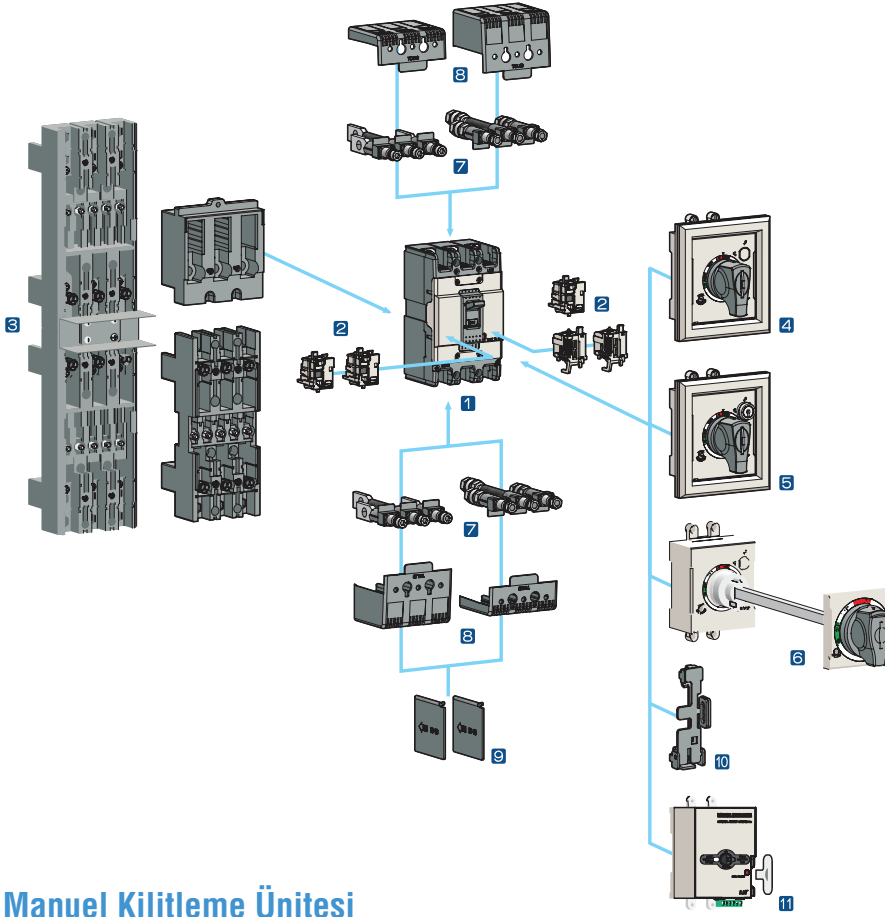

## Genel görünüm

- 1 Şalter
- 2 Dahili yardımcı kontaklar
- 3 Plug-in ünitesi
- 4 Döner kurma kolu (direk)
- 5 Döner kurma kolu (direk, kilitli)
- 6 Döner kurma kolu (uzatmalı)
- 7 Geriye uzatma parçaları
- 8 Terminal kapağı (kısa, uzun)
- 9 İzolasyon bariyeri
- 10 Manuel kilitleme ünitesi
- 11 Motor mekanizması

## Manuel Kilitleme Ünitesi

Model	Beraber kullanılan şalterler		Sipariş Kodu	Açıklama	Liste Fiyatı(\$)
	Şalter	Kaçak akım şalteri			
HL-100c	ABS30c,ABS/N50c,ABS/N60c,ABN100c	EBS30c,EBS/N50c,EBS/N60c,EBN100c	83421187001	HL-100c Manuel Kilitleme Ünitesi	88,00
HL-125c	ABN/S/H/L 125c,ABH50c	EBS/H125c, EBH50c	83421187002	HL-125c Manuel Kilitleme Ünitesi	88,00
HL-250c	ABN/S/H/L 250c	EBN/S/H250c	83421187003	HL-250c Manuel Kilitleme Ünitesi	88,00
HL-400c	ABN/S/H/L 400c,ABN/S/L800c	EBN/S/H/L400c,EBN/S/L800c	83421138001	HL-400c Manuel Kilitleme Ünitesi	88,00

## Mekanik Kilitleme Ünitesi

Model	Beraber kullanılan şalterler		Sipariş Kodu	Açıklama	Liste Fiyatı(\$)
	Şalter	Kaçak akım şalteri			
MI-13	ABS30c,ABS/N50c,ABS/N60c,ABN100c	EBS30c,EBS/N50c,EBS/N60c,EBN100c	56121187001	MI-13 mekanik kilitleme ünitesi	74,00
MI-14			56121187002	MI-14 mekanik kilitleme ünitesi	74,00
MI-23	ABH50c, ABS/H/L125c	EBS125c,EBH50c,EBH125c	56121187003	MI-23 mekanik kilitleme ünitesi	74,00
MI-24			56121187004	MI-24 mekanik kilitleme ünitesi	74,00
MI-33	ABN/S/H/L250c	EBN/S/H250c	56121187005	MI-33 mekanik kilitleme ünitesi	74,00
MI-34			56121187006	MI-34 mekanik kilitleme ünitesi	74,00
MI-43	ABN/S/H/L400c	EBN/S/H/L400c	56121138005	MI-43 mekanik kilitleme ünitesi	107,00
MI-44			56121138007	MI-44 mekanik kilitleme ünitesi	107,00
MI-83	ABN/S/L800c	EBN/S/L800c	56121138006	MI-83 mekanik kilitleme ünitesi	116,00
MI-84			56121138008	MI-84 mekanik kilitleme ünitesi	116,00

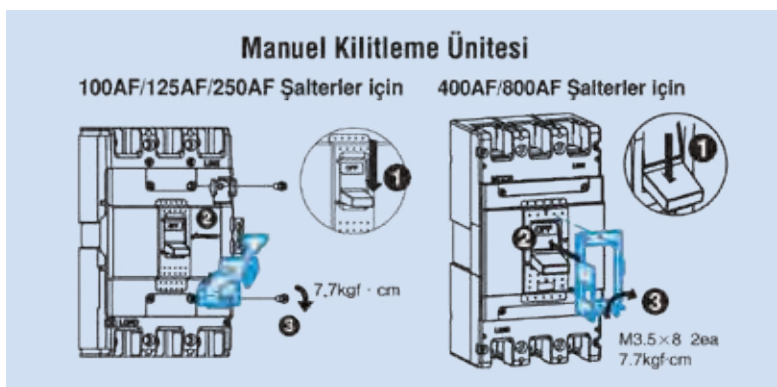

## Motor Mekanizmaları

	Model	Kontrol Gerilimi	Birlikte Kullanılacak Şalter Boyutu		Sipariş Kodu	Açıklama	Liste Fiyatı(\$)
			3P	4P			
	MOP-M1	DC24V	100AF	100AF	83471187901	MOP-M1,DC24V	451,00
		AC230V/ DC220V			83471187903	MOP-M1,AC230V/DC220V	451,00
	MOP-M2	DC24V	125AF	125AF	83471187904	MOP-M2,DC24V	628,00
		AC230V/ DC220V			83471187906	MOP-M2,AC230V/DC220V	628,00
	MOP-M3	DC24V	250AF	250AF	83471187907	MOP-M3,DC24V	851,00
		AC230V/ DC220V			83471187909	MOP-M3,AC230V/DC220V	851,00
	MOP-M4	DC24V	400AF	400AF	83471184901	MOP-M4,DC24V	1.009,00
		AC230V/ DC220V			83471184903	MOP-M4,AC230V/DC220V	1.009,00
	MOP-M5	DC24V	800AF	800AF	83471185901	MOP-M5,DC24V	833,00
		AC230V/ DC220V			83471185903	MOP-M5,AC230V/DC220V	833,00

## Yardımcı Kontaklar &amp; Alarm Kontakları

	Model	Tanımı	Sipariş Kodu	Bağlantı Tipi	Birlikte Kullanılacak Şalter Boyutu	Liste Fiyatı(\$)
	AXRW	YARDIMCI KONTAK, SOL	83011187001	Terminal	30AF ~ 250AF	28,00
	ALRW	ALARM KONTAK, SOL	83011187002			28,00
	AX/AL RW	KOMBİNASYON KONTAK, SOL	83011187003			51,00
	AXTW	YARDIMCI KONTAK, SAĞ	83011187004			28,00
	ALTW	ALARM KONTAK, SAĞ	83011187005			28,00
	AX/AL TW	KOMBİNASYON KONTAK, SAĞ	83011187006			51,00
	AX1LWT	YARDIMCI KONTAK, 1NA+1NK	83011136002	Klemens	400 ~ 800AF	28,00
	AL1LWT	ALARM KONTAK, 1NA+1NK	83011136004			28,00
	AX1LWT	YARDIMCI KONTAK, 2NA+2NK	83011136003			28,00
	AL1LWT	ALARM KONTAK, 2NA+2NK	83011136001			28,00

## Açtırma ve Düşük Gerilim Bobinleri

	Model	Tanımı	Bağlantı Tipi	Sipariş Kodu	Besleme Gerilimi	Birlikte Kullanılacak Şalter Boyutu	Liste Fiyatı(\$)
	SHT24B	AÇTIRMA BOBİNİ (SHT)	Klemens Bloklü	83211187712	AC/DC24V	30AF~250AF	42,00
	SHT200B			83211187715	AC/DC200-250V		42,00
	SHT380B			83211187716	AC380-450V		42,00
	SHT24LWT		83211137001	AC24-48V	400AF-800AF	79,00	
	SHT100LWT		83211137002	AC100-240V - DC100-220V		79,00	
	SHT380LWT		83211137003	AC380-550V		79,00	
	UVT24	DÜŞÜK GERİLİM BOBİNİ (UVT)	Klemens Bloklü	83211187011	AC/DC24V	30AF~250AF	56,00
	UVT200			83211187014	AC/DC200-220V		56,00
	UVT380			83211187015	AC380-440V		56,00
	UVTLWT200		83211137023	AC200-240V - DC200-220V	400AF-800AF	98,00	
UVTLWT380	83211137024		AC380-440V	98,00			

## Döner Kurma Kolları

	Model	Tipi	Birlikte Kullanılan Şalterler		Sipariş Kodu	Açıklama	Liste Fiyatı (\$)
			Şalter	Kaçak Akım Şalteri			
	DH100	Standart Tip	ABS30c/50c/60c	EBS30c/50c/60c	83111187002	DH100 Standart Tip Döner Kurma Kolu	51,00
	DH 125		ABS125c,ABH50c/125c,ABL125c	EBS125c,EBH50c/125c	83111187011	DH125 Standart Tip Döner Kurma Kolu	51,00
	DH 250		ABN/S/H/L250c	EBN/S/H250c	83111187021	DH250 Standart Tip Döner Kurma Kolu	51,00
	N-70		ABN/S/H/L400c	EBN/S/H/L400c	83111138101	N70 Standart Tip Döner Kurma Kolu	135,00
	N-80		ABN/S/L800c	EBN/S/L800c	83111138111	N80 Standart Tip Döner Kurma Kolu	135,00
	DHK100	Standart Kilitli Tip	ABS30c/50c/60c	EBS30c/50c/60c	83111187007	DHK100 Standart Kilitli Tip Döner Kurma Kolu	93,00
	DHK 125		ABS125c,ABH50c/125c,ABL125c	EBS125c,EBH50c/125c	83111187017	DHK125 Standart Kilitli Tip Döner Kurma Kolu	93,00
	DHK 250		ABN/S/H/L250c	EBN/S/H250c	83111187027	DHK250 Standart Kilitli Tip Döner Kurma Kolu	93,00
	EH100		ABS30c/50c/60c	EBS30c/50c/60c	83111187004	EH100 Standart Kilitli Tip Döner Kurma Kolu	79,00
	EH 125		ABS125c,ABH50c/125c,ABL125c	EBS125c,EBH50c/125c	83111187014	EH125 Uzatmalı Tip Döner Kurma Kolu	79,00
EH 250	Uzatmalı	ABN/S/H/L250c	EBN/S/H250c	83111187024	EH250 Uzatmalı Tip Döner Kurma Kolu	79,00	
E-70U		ABN/S/H/L400c	EBN/S/H/L400c	55221138111	E-70U Uzatmalı Tip Döner Kurma Kolu	167,00	
E-80U		ABN/S/L800c	EBN/S/L800c	55221138112	E-80U Uzatmalı Tip Döner Kurma Kolu	195,00	

## Terminal Kapakları

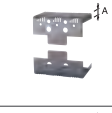
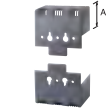
	Model	Tip	Kutup	Sipariş Kodu	Birlikte Kullanılan Şalterler		Liste Fiyatı(\$)
					Şalter	Kaçak akım şalteri	
	TCS23	KISA TİP	3P	64621187215	ABS125c,ABH50c/125c, ABL125c	EBS125c, EBH50c/125c	9,00
	TCS24		4P	64621187216			9,00
	TCS33	KISA TİP	3P	64621187225	ABN/S/H/L250c	EBN/S/H250c	9,00
	TCS34		4P	64621187226			9,00
	TCL23	UZUN TİP	3P	64621187212	ABS125c,ABH50c/125c, ABL125c	EBS125c,EBH50c/125c	9,00
	TCL24		4P	64621187213			9,00
	TCL33	UZUN TİP	3P	64621187222	ABN/S/H/L250c	EBN/S/H250c	9,00
	TCL34		4P	64621187223			9,00



## Trip Üniteleri (100AF - 800AF)

TE ve TD serisi ürünlerin açma üniteleri sabit,  
TS serisi ürünlerin açma üniteleri değiştirilebilir tiptir.



### Model

- TS: Seri
- 250: Maksimum akım
- S: Standart
- N: Normal
- H: Yüksek
- L: Arttırılmış

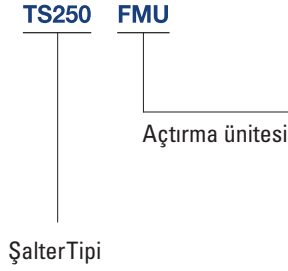

### FTU Sabit termik, sabit manyetik

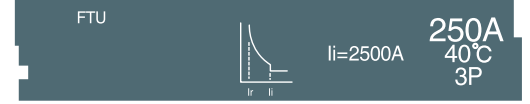

### FMU Ayarlanabilir termik, sabit manyetik

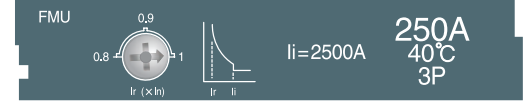

### ATU Ayarlanabilir termik, ayarlanabilir manyetik

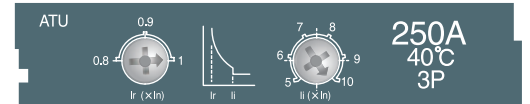

### MTU Ayarlanabilir manyetik

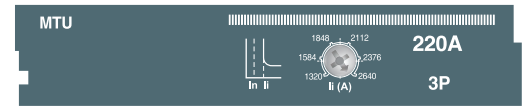

### DSU Yük ayırıcı



### ETS Standart tip elektronik (LSI)

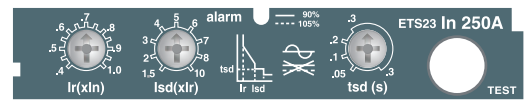

### ETM Çok fonksiyonlu tip elektronik (LSIG)

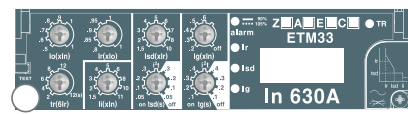

	160AF	250AF	630AF	800AF	1600AF
S	TE100S TE160S	-	-	-	-
N	TE100N TE160N TD100N TD160N	TS100N TS160N TS250N	TS400N TS630N	TS800N	TS1000N TS1250N TS1600N
H	TD100H TD160H	TS100H TS160H TS250H	TS400H TS630H	TS800H	TS1000H TS1250H TS1600H
L	TD100L TD160L	TS100L TS160L TS250L	TS400L TS630L	TS800L	TS1000L

## Akım Değerlerine Göre Şalter Dağılımları

Şalter Tipi	Nominal akım In[A]						
	Açtırma ünitesi				Elektronik açtırma ünitesi		DSU
	FTU	FMU	ATU	MTU	ETS	ETM	
TE100 TD100	16, 20, 25, 32, 40, 50, 63, 80, 100	16, 20, 25, 32, 40, 50, 63, 80, 100	-	-	-	-	-
TE160 TD160	100, 125, 160	100, 125, 160	-	-	-	-	160
TS100	40, 50, 63, 80, 100	40, 50, 63, 80, 100	-	1.6, 3.2, 6.3, 12, 20, 32, 50, 63, 100	40, 80	-	100
TS160	100, 125, 160	100, 125, 160	125, 160	32, 50, 63, 100, 160	40, 80, 160	-	160
TS250	125, 160, 200, 250	125, 160, 200, 250	125, 160, 200, 250	100, 160, 220	40, 80, 160, 250	-	250
TS400	300, 400	300, 400	300, 400	320	160, 250, 400	160, 250, 400	400
TS630	500, 630	500, 630	500, 630	500	160, 250, 400, 630	160, 250, 400, 630	630
TS800	700, 800	800	800	630	630, 800	630, 800	800

## 3 Kutuplu Ayarlanabilir Termik / Sabit Manyetik Tip Kompakt Şalterler (FMU Açırma Ünitesi) (Ics=%100 Icu)

Model	Anma Akımı (A)	Termik Ayar akımı (A)	Manyetik Ayar akımı (A)	Kesme Kapasitesi Icu (kA)	Sipariş Kodu	Açıklama	Liste Fiyatı(\$)
TE100	16A	13-16	400	37kA	01610034	TE100S FMU 16A 3P	209,00
	20A	16-20			01610035	TE100S FMU 20A 3P	209,00
	25A	20-25			01610036	TE100S FMU 25A 3P	209,00
	32A	26-32			01610037	TE100S FMU 32A 3P	209,00
	40A	32-40	Sabit (10In)		01610038	TE100S FMU 40A 3P	209,00
	50A	40-50			01610039	TE100S FMU 50A 3P	209,00
	63A	50-63			01610040	TE100S FMU 63A 3P	209,00
	80A	64-80			01610041	TE100S FMU 80A 3P	209,00
	100A	80-100			01610042	TE100S FMU 100A 3P	209,00
	TE160	125A			100-125	01610043	TE160S FMU 125A 3P
160A		128-160	01610044	TE160S FMU 160A 3P	242,00		
TE100	16A	13-16	400	50kA	01610023	TE100N FMU 16A 3P	228,00
	20A	16-20			01610024	TE100N FMU 20A 3P	228,00
	25A	20-25			01610025	TE100N FMU 25A 3P	228,00
	32A	26-32			01610026	TE100N FMU 32A 3P	228,00
	40A	32-40	Sabit (10In)		01610027	TE100N FMU 40A 3P	228,00
	50A	40-50			01610028	TE100N FMU 50A 3P	228,00
	63A	50-63			01610029	TE100N FMU 63A 3P	228,00
	80A	64-80			01610030	TE100N FMU 80A 3P	228,00
	100A	80-100			01610031	TE100N FMU 100A 3P	228,00
	TE160	125A			100-125	01610032	TE160N FMU 125A 3P
160A		128-160	01610033	TE160N FMU 160A 3P	270,00		
TS250	200A	160-200	Sabit (10In)	01050209	TS250N FMU 200A 3P	367,00	
	250A	200-250		01050210	TS250N FMU 250A 3P	367,00	
TS400	300A	240-300	Sabit (10In)	01080013	TS400N FMU 300A 3P	865,00	
	400A	320-400		01080014	TS400N FMU 400A 3P	865,00	
TS630	500A	400-500	Sabit (10In)	01080019	TS630N FMU 500A 3P	1.028,00	
	630A	504-630		01080020	TS630N FMU 630A 3P	1.028,00	
TS800	800A	640-800	Sabit (10In)	01110008	TS800N FMU 800A 3P	1.358,00	
TS100	16A	13-16	Sabit (10In)	85kA	01020097	TD100H FMU 16A 3P	335,00
	20A	16-20			01020098	TD100H FMU 20A 3P	335,00
	25A	20-25			01020099	TD100H FMU 25A 3P	335,00
	32A	26-32			01020100	TD100H FMU 32A 3P	335,00
	40A	32-40			01020101	TD100H FMU 40A 3P	335,00
	50A	40-50			01020102	TD100H FMU 50A 3P	335,00
	63A	50-63			01020103	TD100H FMU 63A 3P	335,00
	80A	64-80			01020104	TD100H FMU 80A 3P	335,00
	100A	80-100			01020105	TD100H FMU 100A 3P	335,00
	TS160	125A			100-125	Sabit (10In)	01020162
160A		128-160	01020163	TD160H FMU 160A 3P	433,00		
TS250	200A	160-200	Sabit (10In)	01050218	TS250H FMU 200A 3P	526,00	
	250A	200-250		01050219	TS250H FMU 250A 3P	526,00	
TS400	300A	240-300	Sabit (10In)	01080015	TS400H FMU 300A 3P	912,00	
	400A	320-400		01080016	TS400H FMU400 A 3P	912,00	
TS630	500A	400-500	Sabit (10In)	01080021	TS630H FMU500 A 3P	1.405,00	
	630A	504-630		01080022	TS630H FMU630 A 3P	1.405,00	
TS800	800A	640-800	Sabit (10In)	01110010	TS800H FMU800 A 3P	1.502,00	

## 4 Kutuplu Ayarlanabilir Termik / Sabit Manyetik Tip Kompakt Şalterler (FMU Açırma Ünitesi) (Ics=%100 Icu)

Model	Anma Akımı (A)	Termik Ayar akımı (A)	Manyetik Ayar akımı (A)	Kesme Kapasitesi Icu (kA)	Sipariş Kodu	Açıklama	Liste Fiyatı(\$)
TE100	16A	13-16	400	37kA	01620034	TE100S FMU 16A 4P	265,00
	20A	16-20			01620035	TE100S FMU 20A 4P	265,00
	25A	20-25			01620036	TE100S FMU 25A 4P	265,00
	32A	26-32			01620037	TE100S FMU 32A 4P	265,00
	40A	32-40	Sabit (10In)		01620038	TE100S FMU 40A 4P	265,00
	50A	40-50			01620039	TE100S FMU 50A 4P	265,00
	63A	50-63			01620040	TE100S FMU 63A 4P	265,00
	80A	64-80			01620041	TE100S FMU 80A 4P	265,00
	100A	80-100			01620042	TE100S FMU 100A 4P	265,00
	TE160	125A			100-125	01620043	TE160S FMU 125A 4P
160A		128-160	01620044	TE160S FMU 160A 4P	316,00		
TE100	16A	13-16	400	50kA	01620023	TE100N FMU 16A 4P	312,00
	20A	16-20			01620024	TE100N FMU 20A 4P	312,00
	25A	20-25			01620025	TE100N FMU 25A 4P	312,00
	32A	26-32			01620026	TE100N FMU 32A 4P	312,00
	40A	32-40	Sabit (10In)		01620027	TE100N FMU 40A 4P	312,00
	50A	40-50			01620028	TE100N FMU 50A 4P	312,00
	63A	50-63			01620029	TE100N FMU 63A 4P	312,00
	80A	64-80			01620030	TE100N FMU 80A 4P	312,00
	100A	80-100			01620031	TE100N FMU 100A 4P	312,00
	TE160	125A			100-125	Sabit (10In)	01620032
160A		128-160	01620033	TE160N FMU 160A 4P	344,00		
TS250	200A	160-200	Sabit (10In)	01060323	TS250N FMU 200A 4P	535,00	
	250A	200-250		01060324	TS250N FMU 250A 4P	535,00	
TS400	300A	240-300	Sabit (10In)	01090025	TS400N FMU 300A 4P	958,00	
	400A	320-400		01090026	TS400N FMU 400A 4P	958,00	
TS630	500A	400-500	Sabit (10In)	01090031	TS630N FMU 500A 4P	1.312,00	
	630A	504-630		01090032	TS630N FMU 630A 4P	1.312,00	
TS800	800A	640-800	Sabit (10In)	01120014	TS800N FMU 800A 4P	1.693,00	
TD100	16A	13-16	Sabit (10In)	85kA	01030184	TD100H FMU 16A 4P	391,00
	20A	16-20			01030185	TD100H FMU 20A 4P	391,00
	25A	20-25			01030186	TD100H FMU 25A 4P	391,00
	32A	26-32			01030187	TD100H FMU 32A 4P	391,00
	40A	32-40			01030188	TD100H FMU 40A 4P	391,00
	50A	40-50			01030189	TD100H FMU 50A 4P	391,00
	63A	50-63			01030190	TD100H FMU 63A 4P	391,00
	80A	64-80			01030191	TD100H FMU 80A 4P	391,00
	100A	80-100			01030192	TD100H FMU 100A 4P	391,00
	TS160	125A			100-125	Sabit (10In)	01030249
160A		128-160	01030250	TD160H FMU 160A 4P	553,00		
TS250	200A	160-200	Sabit (10In)	01060332	TS250H FMU 200A 4P	642,00	
	250A	200-250		01060333	TS250H FMU 250A 4P	642,00	
TS400	300A	240-300	Sabit (10In)	01090027	TS400H FMU 300A 4P	1.121,00	
	400A	320-400		01090028	TS400H FMU400 A 4P	1.121,00	
TS630	500A	400-500	Sabit (10In)	01090033	TS630H FMU500 A 4P	1.577,00	
	630A	504-630		01090034	TS630H FMU630 A 4P	1.577,00	
TS800	800A	640-800	Sabit (10In)	01120016	TS800H FMU800 A 4P	1.958,00	

## 3 Kutuplu Ayarlanabilir Termik / Ayarlanabilir Manyetik Tip Kompakt Şalterler (ATU Açırma Ünitesi) (Ics=%100 Icu)

Model	Anma Akımı (A)	Termik Ayar akımı (A)	Manyetik Ayar akımı (A)	Kesme Kapasitesi Icu (kA)	Sipariş Kodu	Açıklama	Liste Fiyatı(\$)		
TS160	125A	100-125	Ayarlı (5-10)In	50kA	01050259	TS160N ATU160 125A 3P	335,00		
	160A	128-160			01050258	TS160N ATU160 160A 3P	335,00		
TS250	200A	160-200			01050229	TS250N ATU250 200A 3P	381,00		
	250A	200-250			01050230	TS250N ATU250 250A 3P	381,00		
TS400	300A	240-300			Ayarlı (5-10)In	65kA	01080025	TS400N ATU400 300A 3P	847,00
	400A	320-400					01080026	TS400N ATU400 400A 3P	847,00
TS630	500A	400-500	01080031	TS630N ATU630 500A 3P			1.107,00		
	630A	500-630	01080032	TS630N ATU630 630A 3P			1.107,00		
TS800	800A	640-800	01110013	TS800N ATU800 800A 3P			1.507,00		
TS160	125A	100-125	Ayarlı (5-10)In	85kA			01050257	TS160H ATU160 125A 3P	465,00
	160A	128-160			01050256	TS160H ATU160 160A 3P	465,00		
TS250	200A	160-200			01050231	TS250H ATU250 200A 3P	549,00		
	250A	200-250			01050232	TS250H ATU250 250A 3P	549,00		
TS400	300A	240-300			01080027	TS400H ATU400 300A 3P	953,00		
	400A	320-400			01080028	TS400H ATU400 400A 3P	953,00		
TS630	500A	400-500			01080033	TS630H ATU630 500A 3P	1.488,00		
	630A	500-630			01080034	TS630H ATU630 630A 3P	1.488,00		
TS800	800A	640-800			Ayarlı (5-10)In	100kA	01110014	TS800H ATU800 800A 3P	1.665,00

## 4 Kutuplu Ayarlanabilir Termik / Ayarlanabilir Manyetik Tip Kompakt Şalterler (ATU Açırma Ünitesi) (Ics=%100 Icu)

Model	Anma Akımı (A)	Termik Ayar akımı (A)	Manyetik Ayar akımı (A)	Kesme Kapasitesi Icu (kA)	Sipariş Kodu	Açıklama	Liste Fiyatı(\$)		
TS160	125A	100-125	Ayarlı (5-10)In	50kA	01060470	TS160N ATU160 125A 4P3D	433,00		
	160A	128-160			01060471	TS160N ATU160 160A 4P3D	433,00		
TS250	200A	160-200			01060457	TS250N ATU250 200A 4P3D	549,00		
	250A	200-250			01060458	TS250N ATU250 250A 4P3D	549,00		
TS400	400A	320-400			Ayarlı (5-10)In	65kA	01090050	TS400N ATU400 400A 4P3D	1.070,00
TS630	500A	400-500					01090055	TS630N ATU630 500A 4P3D	1.442,00
	630A	500-630	01090056	TS630N ATU630 630A 4P3D			1.442,00		
TS800	800A	640-800	01120025	TS800N ATU800 800A 4P3D			1.795,00		
TS160	125A	100-125	Ayarlı (5-10)In	85kA			01060472	TS160H ATU160 125A 4P3D	591,00
	160A	128-160					01060473	TS160H ATU160 160A 4P3D	591,00
TS250	200A	160-200			01060459	TS250H ATU250 200A 4P3D	665,00		
	250A	200-250			01060460	TS250H ATU250 250A 4P3D	665,00		
TS400	300A	240-300			01090051	TS400H ATU400 300A 4P3D	1.191,00		
	400A	320-400			01090052	TS400H ATU400 400A 4P3D	1.191,00		
TS630	500A	400-500			01090057	TS630H ATU630 500A 4P3D	1.642,00		
	630A	500-630			01090058	TS630H ATU630 630A 4P3D	1.642,00		
TS800	800A	640-800			Ayarlı (5-10)In	100kA	01120026	TS800H ATU800 800A 4P3D	2.014,00

## 3 Kutuplu Sabit Termik / Ayarlanabilir Manyetik Tip Kompakt Şalterler (MTU Açırma Ünitesi) (Ics=%100 Icu) (Motor Koruma Şalteri)

Model	Anma Akımı (A)	Termik Ayar akımı (A)	Manyetik Ayar akımı (A)	Kesme Kapasitesi Icu (kA)	Sipariş Kodu	Açıklama	Liste Fiyatı(\$)
TS100N	1,6A	-	(6-12) In	50kA	01050314	TS100N MTU 1.6A 3P	279,00
	3,2A	-			01050313	TS100N MTU 3.2A 3P	279,00
	6,3A	-			01050312	TS100N MTU 6.3A 3P	279,00
	12A	-			01050311	TS100N MTU 12A 3P	279,00
	20A	-			01050310	TS100N MTU 20A 3P	247,00
	32A	-			01050309	TS100N MTU 32A 3P	247,00
	50A	-			01050308	TS100N MTU 50 A 3P	247,00
	63A	-			01050307	TS100N MTU 63 A 3P	247,00
	100A	-			01050235	TS100N MTU 100 A 3P	247,00
TS160N	160A	-	65kA	01050241	TS160N MTU 160 A 3P	274,00	
TS250N	220A	-		01050250	TS 250N MTU 220 A 3P	381,00	
TS400N	320A	-		01080037	TS 400N MTU 320 A 3P	707,00	
TS630N	500A	-		01080040	TS 630N MTU 500 A 3P	893,00	
TS 800N	630A	-		01110016	TS 800N MTU 630 A 3P	1.144,00	

## 2/3/4 Kutuplu Kompakt Tip Yük Ayırıcılar (DSU Açırma Ünitesi)

Model	Anma Akımı (A)	Termik Ayar akımı (A)	Manyetik Ayar akımı (A)	Kesme Kapasitesi Icu (kA)	Sipariş Kodu	Açıklama	Liste Fiyatı(\$)
TS100NA	100A	-	-	-	01010182	TD100NA DSU 100A 2P	288,00
	100A	-	-	-	01020182	TD100NA DSU 100A 3P	288,00
	100A	-	-	-	01030362	TD100NA DSU 100A 4P L	367,00
TS160NA	160A	-	-	-	01010181	TD160NA DSU 160A 2P	247,00
	160A	-	-	-	01020181	TD160NA DSU 160A 3P	274,00
	160A	-	-	-	01030361	TD160NA DSU 160A 4P L	353,00
TS200NA	200A	-	-	-	01040527	TS250NA DSU 200A 2P	358,00
	200A	-	-	-	01051194	TS250NA DSU 200A 3P	391,00
	200A	-	-	-	01061849	TS250NA DSU 200A 4P L	512,00
TS250NA	250A	-	-	-	01040235	TS250NA DSU 250A 2P	321,00
	250A	-	-	-	01050253	TS250NA DSU 250A 3P	353,00
	250A	-	-	-	01060469	TS250NA DSU 250A 4P L	465,00
TS400NA	400A	-	-	-	01070037	TS400NA DSU 400A 2P	758,00
	400A	-	-	-	01080043	TS400NA DSU 400A 3P	758,00
	400A	-	-	-	01090073	TS400NA DSU 400A 4P L	972,00
TS630NA	630A	-	-	-	01070038	TS630NA DSU 630A 2P	698,00
	630A	-	-	-	01080044	TS630NA DSU 630A 3P	819,00
	630A	-	-	-	01090074	TS630NA DSU 630A 4P L	949,00
TS800NA	800A	-	-	-	01100016	TS800NA DSU 800A 2P	1.307,00
	800A	-	-	-	01110019	TS800NA DSU 800A 3P	1.088,00
	800A	-	-	-	01120031	TS800NA DSU 800A 4P L	1.507,00
TS1000NA	1000A	-	-	-	01710257	TS1000NA 1000A 3P	1.995,00
	1000A	-	-	-	01750513	TS1000NA 1000A 4P L	2.549,00
TS1250NA	1250A	-	-	-	01720129	TS1250NA 1250A 3P	2.177,00
	1250A	-	-	-	01760257	TS1250NA 1250A 4P L	2.833,00
TS1600NA	1600A	-	-	-	01730129	TS1600NA 1600A 3P	2.586,00
	1600A	-	-	-	01770257	TS1600NA 1600A 4P L	3.470,00

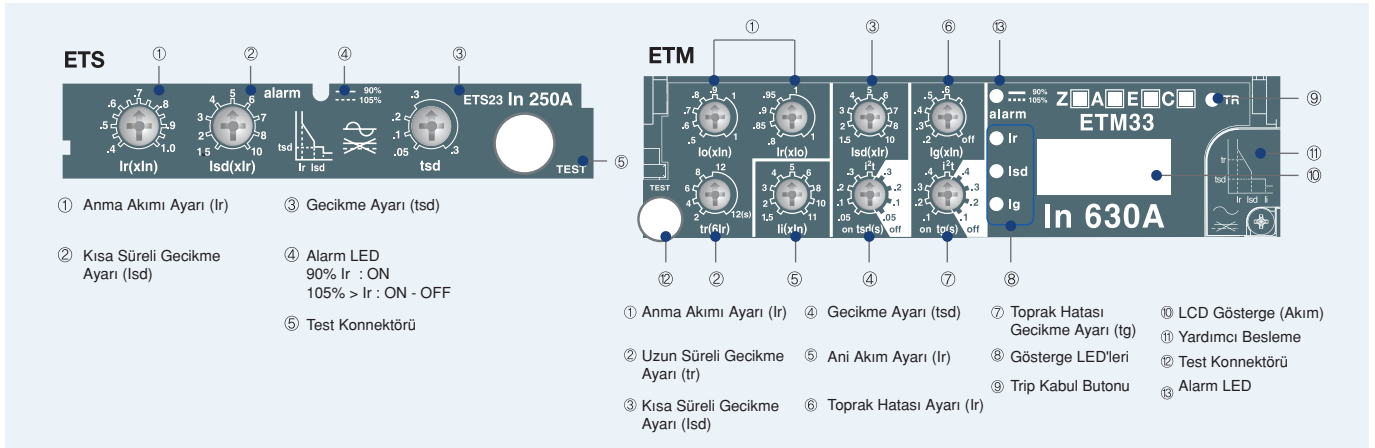

## 3 Kutuplu Standart Elektronik Açırma Üniteli Kompakt Tip Şalterler (ETS Açırma Üniteli) (Ics=%100 Icu)

Model	Anma Akımı (A)	Termik Ayar akımı (A)	Manyetik Ayar akımı (A)	Zaman Gecikme Ayarı (ms)	Kesme Kapasitesi Icu (kA)	Sipariş Kodu	Açıklama	Liste Fiyatı(\$)	
TS 100	40A	32-40	Ayarlı (1.5-10) In	Ayarlı (0.05-3)	50kA	01050260	TS100N ETS23 40 A 3P	433,00	
	80A	63-80				01050263	TS100N ETS23 80 A 3P	433,00	
	100A	80-100				01050769	TS100N ETS23 100 A 3P	433,00	
TS 160	160A	128-160				01050272	TS250N ETS23 160 A 3P	405,00	
	TS 250	250A				200-250	01050284	TS250N ETS23 250 A 3P	493,00
		TS 400				400A	320-400	01080051	TS400N ETS33 400 A 3P
TS 630	630A				500-630	01080063	TS630N ETS33 630 A 3P	1.400,00	
	TS 800	800A			640-800	01110023	TS800N ETS43 800 A 3P	1.600,00	

## 4 Kutuplu Standart Elektronik Açırma Üniteli Kompakt Tip Şalterler (ETS Açırma Üniteli) (Ics=%100 Icu)

Model	Anma Akımı (A)	Termik Ayar akımı (A)	Manyetik Ayar akımı (A)	Zaman Gecikme Ayarı (ms)	Kesme Kapasitesi Icu (kA)	Sipariş Kodu	Açıklama	Liste Fiyatı(\$)	
TS 100	40A	32-40	Ayarlı (1.5-10) In	Ayarlı (0.05-3)	50kA	01061020	TS100N ETS23 40 A 4P	447,00	
	80A	63-80				01061026	TS100N ETS23 80 A 4P	447,00	
	100A	80-100				01061653	TS100N ETS23 100 A 4P	447,00	
TS 160	160A	128-160				01061044	TS250N ETS23 160 A 4P	460,00	
	TS 250	250A				200-250	01061068	TS250N ETS23 250 A 4P	744,00
		TS 400				400A	320-400	01090317	TS400N ETS33 400 A 4P
TS 630	630A				500-630	01090341	TS630N ETS33 630 A 4P	1.665,00	
	TS 800	800A			640-800	01120117	TS800N ETS43 800 A 4P	1.926,00	

## 3 Kutuplu Çok Fonksiyonlu Elektronik Açırma Üniteli Kompakt Tip Şalterler (ETM Açırma Üniteli) (Ics=%100 Icu)

Model	Anma Akımı (A)	Termik Ayar akımı (A)	Manyetik Ayar akımı (A)	Zaman Gecikme Ayarı (ms)	Kesme Kapasitesi Icu (kA)	Sipariş Kodu	Açıklama	Liste Fiyatı(\$)
TS 400	160A	128-160	Ayarlı (1.5-10) In	Ayarlı (50-300)	65A	01080066	TS400N ETM33 160A 3P	1.330,00
	250A	200-250				01080069	TS400N ETM33 250A 3P	1.330,00
	400A	320-400				01080072	TS400N ETM33 400A 3P	1.330,00
TS 630	630A	504-630				01080084	TS630N ETM33 630A 3P	1.795,00
	TS 800	800A				640-800	01110029	TS800N ETM43 800A 3P

## 4 Kutuplu Çok Fonksiyonlu Elektronik Açırma Üniteli Kompakt Tip Şalterler (ETM Açırma Üniteli) (Ics=%100 Icu)

Model	Anma Akımı (A)	Termik Ayar akımı (A)	Manyetik Ayar akımı (A)	Zaman Gecikme Ayarı (ms)	Kesme Kapasitesi Icu (kA)	Sipariş Kodu	Açıklama	Liste Fiyatı(\$)
TS 400	160A	128-160	Ayarlı (1.5-10) In	Ayarlı (50-300)	65A	01090347	TS400N ETM33 160A 4P L	1.470,00
	250A	200-250				01090353	TS400N ETM33 250A 4P L	1.470,00
	400A	320-400				01090359	TS400N ETM33 400A 4P L	1.470,00
TS 630	630A	504-630				01090383	TS630N ETM33 630A 4P L	1.981,00
	TS 800	800A				640-800	01120129	TS800N ETM43 800A 4P L

## ETM Tip Açırma Üniteleri İçin Opsiyonlar

Opsiyon	Şalter Tipi	Referans
A	TS 400 <input type="checkbox"/> ETM	A: Ampermetre E: Toprak Kaçak Koruma Z: Selektif Koruma Modülü C: Haberleşme
E	TS 630 <input type="checkbox"/> ETM	
Z	TS 800 <input type="checkbox"/> ETM	
A+E	TS 400 <input type="checkbox"/> ETM	A: Ammeter E: Earth Fault Protection Z: Zone Selective Interlocking C: Communication
A+C	TS 630 <input type="checkbox"/> ETM	
Z+A	TS 800 <input type="checkbox"/> ETM	
A+E+C	TS 400 <input type="checkbox"/> ETM	
Z+A+E	TS 630 <input type="checkbox"/> ETM	
Z+A+C	TS 800 <input type="checkbox"/> ETM	
Z+A+E+C	TS 400 <input type="checkbox"/> ETM	
	TS 630 <input type="checkbox"/> ETM	
	TS 800 <input type="checkbox"/> ETM	

\* Örnek/ "TS630H ETM33 630A 3P"ye  
"Ampermetre & Toprak Arıza Koruma" fonksiyonu  
eklenmesi halinde

• Ürün adı "TS630H ETM33 630A 3P AE" olur.  
(Sipariş vermeden önce mutlaka kontrol ediniz)

• Ürün Fiyatı "TS630H ETM33 630A 3P temel fiyat  
+ opsiyon fiyatıdır"

• Ürünlerin fiyat bilgisi için yetkili satış kanallarımız ile  
temasa geçebilirsiniz.

## Ürün Ailesi Genel Görünümü (1000AF/1600AF)



Model		
Amper		
Kutup		
Anma Akımı,(A)	In	-5~40°C 50°C 65°C
Anma Yalıtım Gerilimi,(V)	Ui	
Anma Darbe Dayanma Gerilimi,(kV)	Uimp	
Anma Çalışma Gerilimi,(V)	Ue	AC50/60Hz DC
Anma Maksimum Kısa Devre Kesme Kapasitesi		
IEC60947-2	Anma Maksimum	220/240V
AC50/60Hz	Kısa Devre Kesme	380/415V
(sym)	Kapasitesi (kA) (Icu)	AC
		440/460V
		480/500V
		660/690V
	DC	250V 2P
		500V 2P
		750V 3P
	Anma İşletme Kısa Devre Kesme	
	Kapasitesi, Ics (%Icu) (kA)	
	Belirtilen Kısa Süreli Dayanma Akımı	1s
	(kA) (Icw) AC50/60Hz	3s
İlk Anlık Koruma		kA peak
İzolasyon		
Kullanım Kategorisi		
	Mekaniksel Ömür	
	Elektriksel Ömür	440V In/2 In 690V In/2 In
Kirlilik Derecesi		
Boyutlar (mm)		3-kutup
(W×H×D)		4-kutup
Ağırlık (kg)		3-kutup 4-kutup

TS1000			TS1250		TS1600	
TS1000			TS1250		TS1600	
1000			1250		1600	
3, 4			3, 4		3, 4	
800, 1000			1250		1600	
800, 1000			1250		1560	
800, 1000			1240		1420	
1000			1000		1000	
8			8		8	
690			690		690	
-			-		-	
N	H	L	N	H	N	H
55	75	200	55	75	55	75
50	70	150	50	70	50	70
50	65	130	50	65	50	65
40	50	100	40	50	40	50
35	45	-	35	45	35	45
-	-	-	-	-	-	-
-	-	-	-	-	-	-
-	-	-	-	-	-	-
100%	75%	100%	100%	75%	100%	75%
25		12	25		25	
-		-	-		-	
50		30	50		50	
○			○		○	
B		A	B		B	
10000		4000	10000		10000	
6000		4000	5000		5000	
5000		3000	4000		2000	
4000		3000	3000		2000	
2000		2000	2000		1000	
3			3		3	
			210×327×152.5			
			280×327×152.5			
			13			
			16.8			

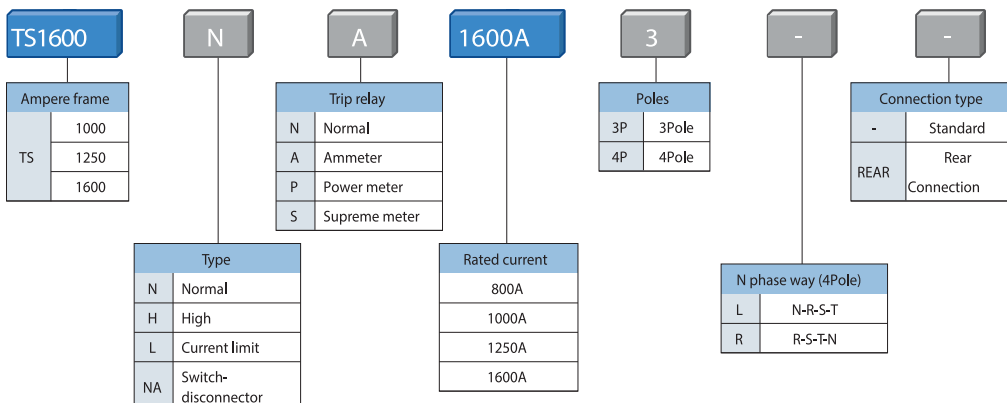

## 3/4 Kutuplu Kompakt Tip Şalterler (NGO Tip Açırma Ünitesi, 1000AF/1600AF)\*

Model	Anma Akımı (A)	Termik Ayar Akımı (A)	Kesme Kapasitesi Icu (kA)	Kutup Sayısı	Sipariş Kodu	Açıklama	Liste Fiyatı(\$)
TS1000N	800A	400-800A	50	3P	01710001	TS1000N NGO 800A 3P	2.553,00
TS1000N	1000A	500-1000A			01710065	TS1000N NGO 1000A 3P	2.558,00
TS1250N	1250A	625-1250A			01720001	TS1250N NGO 1250A 3P	2.935,00
TS1600N	1600A	800-1600A			01730001	TS1600N NGO 1600A 3P	4.047,00
TS1000H	800A	400-800A	70	3P	01710129	TS1000H NGO 800A 3P	2.758,00
TS1000H	1000A	500-1000A			01710193	TS1000H NGO 1000A 3P	2.688,00
TS1250H	1250A	625-1250A			01720065	TS1250H NGO 1250A 3P	3.102,00
TS1600H	1600A	800-1600A			01730065	TS1600H NGO 1600A 3P	4.279,00
TS1000N	800A	400-800A	50	4P	01750001	TS1000N NGO 800A 4P L	3.605,00
TS1000N	1000A	500-1000A			01750065	TS1000N NGO 1000A 4P L	3.614,00
TS1250N	1250A	625-1250A			01760001	TS1250N NGO 1250A 4P L	3.991,00
TS1600N	1600A	800-1600A			01770001	TS1600N NGO 1600A 4P L	5.474,00
TS1000H	800A	400-800A	70	4P	01750129	TS1000H NGO 800A 4P L	3.712,00
TS1000H	1000A	500-1000A			01750193	TS1000H NGO 1000A 4P L	4.172,00
TS1250H	1250A	625-1250A			01760065	TS1250H NGO 1250A 4P L	4.572,00
TS1600H	1600A	800-1600A			01770065	TS1600H NGO 1600A 4P L	6.242,00

\* Fiyat listesindeki ürünler NGO açırma ünitesi olup, farklı tip ürünlerimiz için yetkili satış kanallarımız ile temasa geçebilirsiniz.

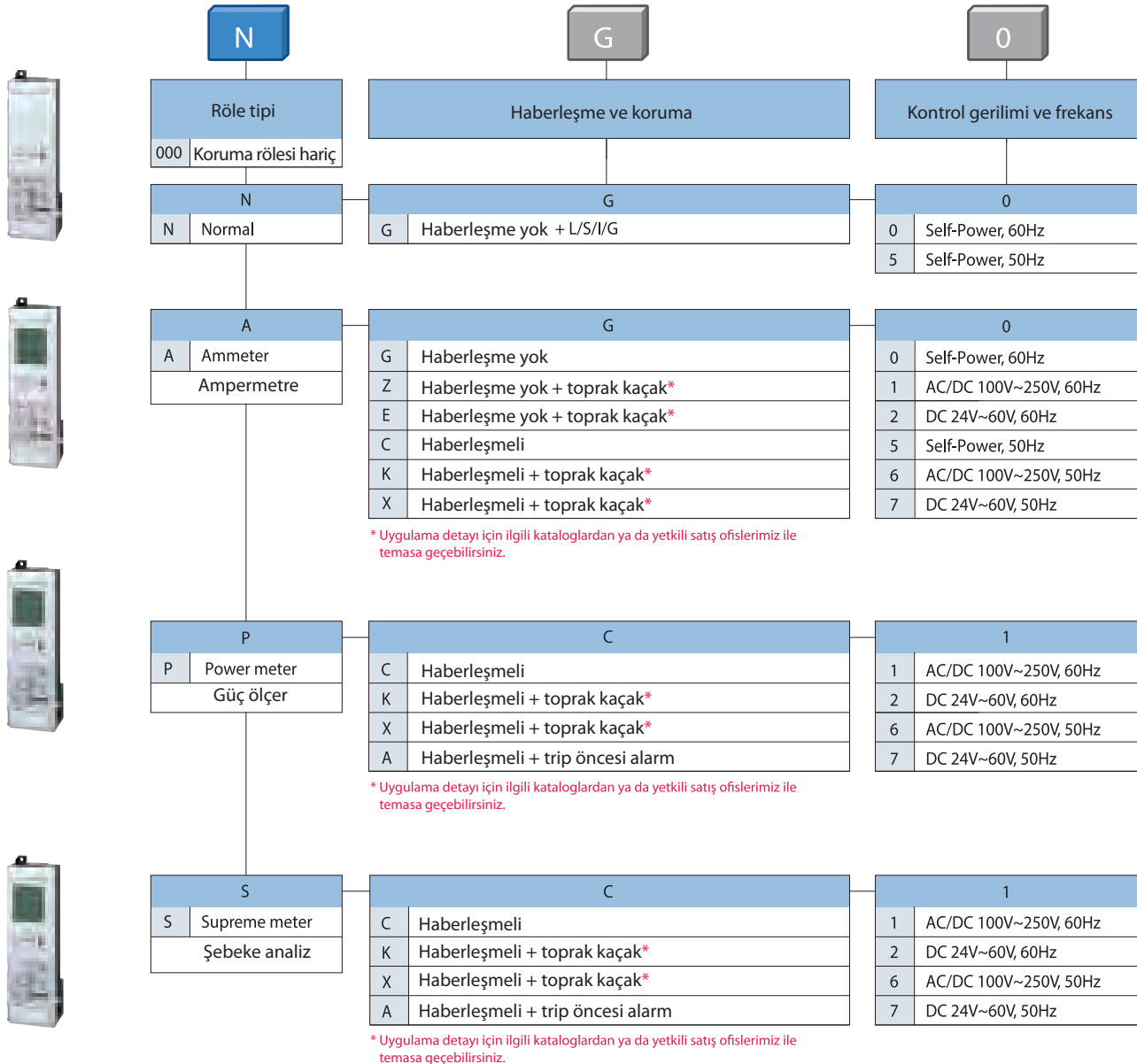

## Yardımcı Donanımlar

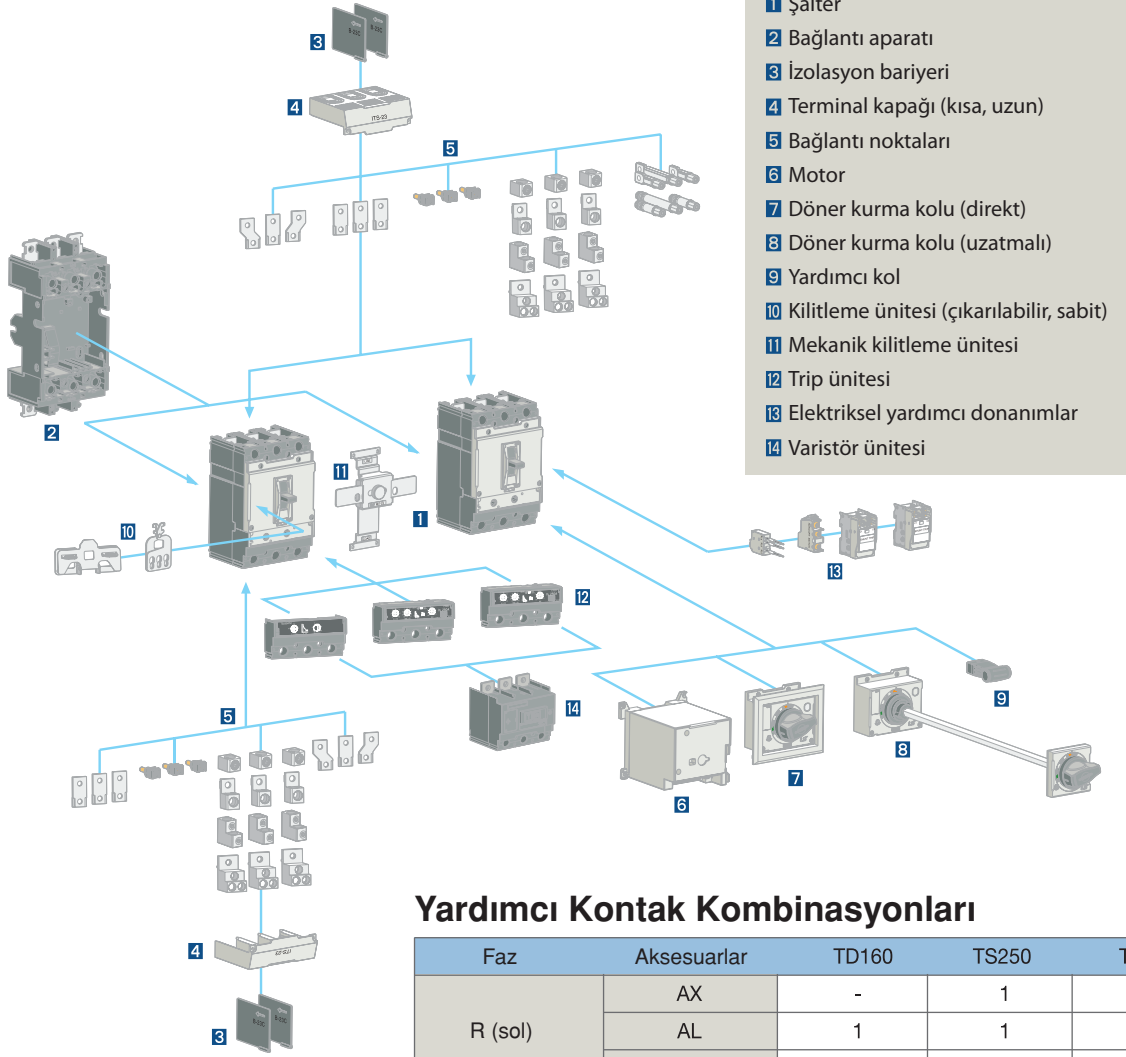

## Yardımcı Kontakt Kombinasyonları

Faz	Aksesuarlar	TD160	TS250	TS630	TS800
R (sol)	AX	-	1	3	3
	AL	1	1	-	-
	SHT or UVT	1	1	1	1
T (sağ)	AX	2	1	-	-
	AL	-	-	1	2
	FAL	-	1	1	1

Not: FAL sadece MCCB'lerin elektronik tip trip ünitelerinde kullanılır.

## Mekanik Kilitler (Changeover için)

Model	Tip	3/4 Kutup	Sipariş Kodu	Açıklama	Liste Fiyatı(\$)
MIT13E	MEKANİK KİLİT	3-kutup	56121175801	TD100/TD160 için	88,00
MIT14E		4-kutup	56121175802		88,00
MIT13		3-kutup	56121171811		177,00
MIT14		4-kutup	56121171812		177,00
MIT23		3-kutup	56121172811	TS100/160/250 için	186,00
MIT24		4-kutup	56121172812		186,00
MIT33		3-kutup	56121173813	TS400/630 için	223,00
MIT34		4-kutup	56121173814		223,00
MIT43		3-kutup	56121174813	TS800 için	247,00
MIT44		4-kutup	56121174814		247,00
MIT53	3-kutup	56121176801	TS1600 için	256,00	

## Manuel Kilitleme Üniteleri

Model	Fonksiyon	Berber kullanılan şalterler	Sipariş Kodu	Açıklama	Liste Fiyatı(\$)	
PHL1, PHL2, PHL3, PHL4	Sabit Tip	ON yada OFF Pozisyonunda	TD160	56771171802	LOCK ASS'Y,PHL1,TD160	51,00
			TS250	56771172802	LOCK ASS'Y,PHL2,TS250	51,00
			TS630	56771173802	LOCK ASS'Y,PHL3,TS630	60,00
			TS800	56771174802	LOCK ASS'Y,PHL4,TS800	74,00
PL1, PL2, PL3, PL4	Çıkarılabilir Tip	OFF Pozisyonunda	TD160	56771171801	LOCK ASS'Y,PL1,TD160	60,00
			TS250	56771172801	LOCK ASS'Y,PL2,TS250	65,00
			TS630	56771173801	LOCK ASS'Y,PL3,TS630	56,00
			TS800	56771174801	LOCK ASS'Y,PL4,TS800	60,00

## Yardımcı Donanımlar

### Motor Mekanizmaları

Model	Kontrol Gerilimi	Kullanılacak Şalter Tipleri	Sipariş Kodu	Açıklama	Liste Fiyatı(\$)
MOP-M1	DC24V	TD100,TD160	83471171901	MOTOR MEKANİZMASI,MOP1,DC24V	451,00
	AC100~240V		83471171902	MOTOR MEKANİZMASI,MOP1,AC100~240V/DC100~220V	451,00
MOP-M2	DC24V	TS100, TS160, TS250	83471172901	MOTOR MEKANİZMASI,MOP2,DC24V	628,00
	AC110V/ DC110V		83471172902	MOTOR OPERATOR,MOP2,AC110V/DC110V	628,00
	AC230V/ DC220V		83471172903	MOTOR MEKANİZMASI,MOP2,AC230V/DC220V	628,00
MOP-M3	DC24V	TS400, TS630	83471173901	MOTOR MEKANİZMASI,MOP3,DC24V	851,00
	AC110V/ DC110V		83471173902	MOTOR OPERATOR,MOP3,AC110V/DC110V	851,00
	AC230V/ DC220V		83471173903	MOTOR MEKANİZMASI,MOP3,AC230V/DC220V	851,00
MOP-M4	DC24V	TS800	83471174901	MOTOR MEKANİZMASI,MOP4,DC24V	1.009,00
	AC110V/ DC110V		83471174902	MOTOR OPERATOR,MOP4,AC110V/DC110V	1.009,00
	AC230V/ DC220V		83471174903	MOTOR MEKANİZMASI,MOP4,AC230V/DC220V	1.009,00
MOP-M7	DC24V	TE100,TE160	83471175901	MOTOR MEKANİZMASI,MOP-M7,DC24V,	391,00
	AC230V/ DC220V		83471175903	MOTOR MEKANİZMASI,MOP-M7,AC230V/DC220V	391,00

### TE100-160 Serisi İçin Yardımcı Donanımlar

Model	Tanımı	Bağlantı Tipi	Sipariş Kodu	Açıklama	Liste Fiyatı(\$)
AX	Yardımcı Kontakt	Kablo Bağlantılı	83011175701	A,AX,R,W,TE160	42,00
			83011175704	A,AX,T,W,TE160	42,00
AL	Alarm Konağı	Kablo Bağlantılı	83011175702	A,AL,R,W,TE160	42,00
			83011175705	A,AL,T,W,TE160	42,00
AX+AL	Kombine Kontakt	Kablo Bağlantılı	83011175703	A,AX/AL,R,W,TE160	70,00
			83011175706	A,AX/AL,T,W,TE160	70,00
SHT	Açtırma Bobini	Klemens Bloku	83211175732	T,SHT,T,AC/DC24V,TE160	65,00
			83211175736	T,SHT,T,AC/DC200~250V,TE160	65,00
			83211175737	T,SHT,T,AC 380~450V,TE160	65,00
UVT	Düşük Gerilim Bobini	Klemens Bloku	83211175751	T,UVT,T,AC/DC24V,TE160	126,00
			83211175754	T,UVT,T,AC/DC200~220V,TE160	126,00
			83211175755	T,UVT,T,AC380~440V,TE160	126,00

### TD100-TS1600 Serisi İçin Yardımcı Donanımlar

Model	Tanımı	Sipariş Kodu	Açıklama	Liste Fiyatı(\$)
AX	YARDIMCI KONTAK	83011171701	A,AX,TD100-TS800 İÇİN	42,00
AX	YARDIMCI KONTAK	83011171704	A,AX,LWT,TD100-TS800	42,00
AL	ALARM KONTAĞI	83011171702	A,AL,TD100-TS800 İÇİN	42,00
FAL	HATA KONTAĞI	83011171703	A,FAL,TD100-TS800 İÇİN	79,00
AX1	YARDIMCI KONTAK	83011176201	A,AX,TS1600 İÇİN	42,00
AL1	ALARM KONTAĞI	83011176203	A,AL,TS1600 İÇİN	42,00
FAL1	HATA KONTAĞI	83011176251	A,FAL,TS1600 İÇİN	88,00
SHT24S	Açtırma Bobini	83211171732	T,SHT,AC/DC24V,TD100-TS800 İÇİN	74,00
SHT220S		83211171735	T,SHT,AC220~240VDC250V,TD100-TS800 İÇİN	74,00
SHT380S		83211171736	T,SHT,AC/DC380~500V,TD100-TS800 İÇİN	74,00
SHT24S1		83211176221	T,SHT,DC24~30V,TS1600 İÇİN	135,00
SHT201S		83211176224	T,SHT,AC/DC200~250V,TS1600 İÇİN	135,00
SHT381S		83211176225	T,SHT,AC380~480V,TS1600 İÇİN	135,00
UVT24S	Düşük Gerilim Bobini	83211171751	T,UVT,AC/DC24V,TD100-TS800 İÇİN	126,00
UVT220S		83211171754	T,UVT,AC220~240V/DC250V,TD100-TS800 İÇİN	126,00
UVT380S		83211171755	T,UVT,AC380~440V,TD100-TS800 İÇİN	126,00
UVT24S1		83211176241	T,UVT,DC24~30V,TS1600 İÇİN	167,00
UVT201S		83211176244	T,UVT,ADC200~250V,TS1600 İÇİN	167,00
UVT381S		83211176245	T,UVT,AC380~480V,TS1600 İÇİN	167,00

## Yardımcı Donanımlar

### TS Serisi Kaçak Akım Algılama Modülleri

Model	Birlikte Kullanılacak Şalter Tipleri	Sipariş Kodu	Açıklama	Liste Fiyatı (\$)
RTU23	TS100/160	83481172601	RCD,RTU23,AC220/460V,TS100/160	465,00
		83481172602	RCD,RTU23,AC460/690V,TS100/160	465,00
	TS250	83481172603	RCD,RTU23,AC220/460V,TS250	465,00
		83481172604	RCD,RTU23,AC460/690V,TS250	465,00
RTU33	TS400	83481173601	RCD,RTU33,AC220/460V,TS400	660,00
		83481173602	RCD,RTU33,AC460/690V,TS400	660,00
	TS630	83481173603	RCD,RTU33,AC220/460V,TS630	660,00
		83481173604	RCD,RTU33,AC460/690V,TS630	660,00
RTU43	TS800	83481174601	RCD,RTU43,AC220/460V,TS800	884,00
		83481174602	RCD,RTU43,AC460/690V,TS800	884,00

		RTU23	RTU24	RTU33	RTU34	RTU43
Kutup sayısı		3*	4	3*	4	3*
Birlikte kullanılacak şalter	TS100	■	■			
	TS160	■	■			
	TS250	■	■			
	TS400			■	■	
	TS630			■	■	
	TS800					■
Koruma karakteristikleri						
Hassasiyet	$I_{\Delta n}$ (A)	(ayarlanabilir) 0.03-0.3-1-3-10				
Zaman gecikmesi **	Kasıtlı zaman gecikmesi (ms)	(ayarlanabilir) 0-60-150-300-600				
	Max. breaking time (ms)	(ayarlanabilir) 40-150-300-600-990				
Çalışma gerilimi	AC 50/60 Hz	220-460V / 460-690V				

2) RTU can not be applied to MCCB (Electronic trip unit) + D/E-Handle

- Not 1) RTU, 63A veya daha düşük MTU tipi MCCB'ye uygulanamaz.  
 2) MCCB (Elektronik açma ünitesi) + D/E-Tutamak'a RTU uygulanamaz.  
 3) RTU24, RTU34: Yalnızca N-R-S-T tipi MCCB kombinasyonu mümkündür.  
 4) RTU24 sadece Temmuz 18'den sonra üretilen termik-manyetik ünite ve Mart'tan sonra üretilen elektronik ünite ile birleştirilebilir. 2019.  
 5) RTU34, sadece Eylül ayından sonra üretilen termik-manyetik ünite ve elektronik ünite ile kombine edilebilir. 2019.  
 \* 3P modülleri 2P devre kesicilerde de kullanılabilir.  
 \*\* Hassasiyet 30mA olarak ayarlanırsa zaman gecikmesi ayarı sıfıra düşürülür.

Trip zaman gecikme ayarı  
0-60-150-300-600ms

Hassasiyet ayarı  $I_{\Delta n}$   
0.03-0.3-1-3-10A



### Çekmece (Plug-in) Ünitesi

Model	Birlikte Kullanılacak Şalter Tipleri	Kutup Sayısı	Sipariş Kodu	Açıklama	Liste Fiyatı (\$)
PB 12	TD100,160	2P	83171171001	PLUG-IN,PB12,TD100,TD160	172,00
PB 13		3P	83171171002	PLUG-IN,PB13,TD100,TD160	242,00
PB 12 D2		2P	83171171003	PLUG-IN,PB12D2,TD100,TD160	340,00
PB 13 D2		3P	83171171004	PLUG-IN,PB13D2,TD100,TD160	484,00
PB 22	TS100,160,250	2P	83171172001	PLUG-IN,PB22,TS100,TS160,TS250	223,00
PB 23		3P	83171172002	PLUG-IN,PB23,TS100,TS160,TS250	302,00
PB 32	TS400,630	2P	83171173001	PLUG-IN,PB32,TS400,TS630	372,00
PB 33		3P	83171173002	PLUG-IN,PB33,TS400,TS630	544,00
PB 42	TS800	2P	83171174001	PLUG-IN,PB42,TS800	1.014,00
PB 43		3P	83171174002	PLUG-IN,PB43,TS800	1.479,00

### Çekmece (Plug-in) Ünitesi Konnektör Kiti

Model	Birlikte Kullanılacak Şalter Tipleri	Sipariş Kodu	Açıklama	Liste Fiyatı (\$)
Hareketli Parça	TD160	83261171806	SPARE PART ASS'Y,BASE CONNECTOR,TD160	14,00
	TS250	83261172804	SPARE PART ASS'Y,BASE CONNECTOR,TS250	14,00
	TS630	83261173806	SPARE PART ASS'Y,BASE CONNECTOR,TS630	14,00
	TS800	83261174806	SPARE PART ASS'Y,BASE CONNECTOR,TS800	14,00
Sabit Parça	TD160~TS800	83261171807	SPARE PART ASS'Y,CONNECTOR KIT,TD160	60,00

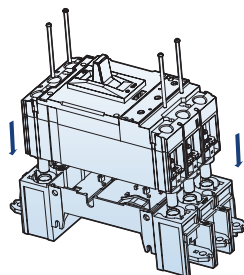

Plug In Ünitesi

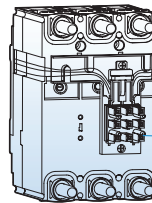

Sabit Parça

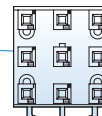

Hareketli Parça

## Yardımcı Donanımlar

### Kurma Kolları

	Model	Tanımı	Sipariş Kodu	Açıklama	Liste Fiyatı (\$)
	DH1E	Standart	83111175801	KURMA KOLU,DH1-E,TE160 İÇİN	42,00
	DH1		83111171801	KURMA KOLU,DH1-S,TD160 İÇİN	70,00
	DH2		83111172801	KURMA KOLU,DH2-S,TS250 İÇİN	70,00
	DH3		83111173801	KURMA KOLU,DH3-S,TS630 İÇİN	130,00
	DH4		83111174801	KURMA KOLU,DH4-S,TS800 İÇİN	181,00
	DH5		83111176281	KURMA KOLU,DH5-S,TS1600 İÇİN	544,00
	EH1E	Uzatmalı	83111175804	KURMA KOLU,EH1-E,TE160 İÇİN	102,00
	EH1		83111171806	KURMA KOLU,EH1-S,TD160 İÇİN	116,00
	EH2		83111172806	KURMA KOLU,EH2-S,TS250 İÇİN	116,00
	EH3		83111173806	KURMA KOLU,EH3-S,TS630 İÇİN	195,00
	EH4		83111174806	KURMA KOLU,EH4-S,TS800 İÇİN	219,00
	EH5	STANDART - KİLİTLİ TİP	83111176294	KURMA KOLU,EH5-S,TS1600 İÇİN	609,00
	DHK1		83111171811	KURMA KOLU,DHK1-S,TD160 İÇİN	140,00
	DHK2		83111172811	KURMA KOLU,DHK2-S,TS250 İÇİN	140,00
	DHK3		83111173811	KURMA KOLU,DHK3-S,TS630 İÇİN	200,00
	DHK4		83111174811	KURMA KOLU,DHK4-S,TS800 İÇİN	228,00
	DHK5		83111176287	KURMA KOLU,DHK5-S,TS1600 İÇİN	707,00

### Terminal Kapakları

	Model	Tip	3/4 Kutup	Sipariş Kodu	Açıklama	Liste Fiyatı (\$)	
	ITS13E	KISA TİP	3-Kutup	64621175301	TERMINAL KAPAĞI	ITS13E,TE160 İÇİN	9,00
	ITS14E		4-Kutup	64621175303		ITS14E,TE160 İÇİN	9,00
	ITS13L	UZUN TİP	3-Kutup	64621175305	TERMINAL KAPAĞI	ITS13E,TE160 İÇİN	14,00
	ITS14L		4-Kutup	64621175306		ITS14E,TE160 İÇİN	14,00
	ITS13	KISA TİP	3-Kutup	64621171011	TERMINAL KAPAĞI	ITS13,TD160 İÇİN	14,00
	ITS14		4-Kutup	64621171012		ITS14,TD160 İÇİN	14,00
	ITL13	UZUN TİP	3-Kutup	64621171013	TERMINAL KAPAĞI	ITL13,TD160 İÇİN	19,00
	ITL14		4-Kutup	64621171014		ITL14,TD160 İÇİN	19,00
	ITS23	KISA TİP	3-Kutup	64621172011	TERMINAL KAPAĞI	ITS23,TS250 İÇİN	14,00
	ITS24		4-Kutup	64621172015		ITS24,TS250 İÇİN	14,00
	ITL23	UZUN TİP	3-Kutup	64621172016	TERMINAL KAPAĞI	ITL23,TS250 İÇİN	28,00
	ITL24		4-Kutup	64621172017		ITL24,TS250 İÇİN	33,00
	ITS33	KISA TİP	3-Kutup	64621173011	TERMINAL KAPAĞI	ITS33,TS630 İÇİN	23,00
	ITS34		4-Kutup	64621173012		ITS34,TS630 İÇİN	28,00
	ITL33	UZUN TİP	3-Kutup	64621173013	TERMINAL KAPAĞI	ITL33,TS630 İÇİN	51,00
	ITL34		4-Kutup	64621173014		ITL34,TS630 İÇİN	56,00
	ITS43	KISA TİP	3-Kutup	64621174011	TERMINAL KAPAĞI	ITS43,TS800 İÇİN	33,00
	ITS44		4-Kutup	64621174012		ITS44,TS800 İÇİN	37,00
	ITL43	UZUN TİP	3-Kutup	64621174013	TERMINAL KAPAĞI	ITL43,TS800 İÇİN	88,00
	ITL44		4-Kutup	64621174014		ITL44,TS800 İÇİN	112,00

### İzolasyon Bariyerleri

	Model	Beraber kullanılan şalterler	Sipariş Kodu	Açıklama	Liste Fiyatı (\$)
	B-23C	TD160,TS160	83261171081	B-23C İzolasyon bariyeri	381,00
	B-33C	TS400,TS630	83261173081	B-33C İzolasyon bariyeri	526,00
	B-43C	TS800	83261174081	B-43C İzolasyon bariyeri	502,00

# Açık Tip Şalterler



**LS** ELECTRIC

Susol Compact Icu=50 & 60 kA, In=800-1600A,

## Açık Tip Şalter Seçeneklerinizi Gözden Geçirin

High Performance  
Ics=100%\*Icu

Açık Tip Şalter İhtiyaçlarımız için  
Boyut ve Maliyet Açısından  
Yeni Bir Evrim

Compact Size  
55%↓

Performance ↑  
Size ↓



## Susol Super Solution Compact ACB 1600A

- Cat.A 150kA/415V
- Cat.B 50kA/690V, Icw = 50kA/1sec (30kA/3sec)

Fonksiyon Gereksimlerine bağlı olarak farklı koruma rölesi seçenekleri



### N Tip (Normal)

Termik Koruma  
L/S/I/G Termik  
Enerji Beslemesi Gerektirmez  
Dahili RTC  
Hata Göstergesi (LED)

N  
type

### P Tip (Güç Ölçer)

A Tipinde yer alan tüm özelliklere ek olarak  
Güç Ölçümü / Gerilim / Akım  
Dengesiz Yük Koruma  
L/S/I/G  
Termik  
UV / OV / OF / UF / rP / Vun / Iun  
V/A/Wh/F/PF  
ZSI(Alan Seçicili Kilitleme)  
Uzaktan Reset  
Modbus/RS-485  
Profibus DP  
AC/DC 100-250V  
DC 24-60V  
Dahili RTC  
Olay ve Hata Kaydı (256+256)

P  
type

### A Tip (Akım Ölçer)

Akım Ölçer + Akım Koruma  
+ DO koruma + Haberleşme  
L/S/I/G  
Termik  
ZSI(Alan Seçici Kilitleme)  
Uzaktan Reset  
Modbus/RS-485  
Profibus DP  
Enerji Beslemesi Gerektirmez  
AC/DC 100-250V  
DC 24-60V  
Dahili RTC  
Kayıt Alma Yeteneği

A  
type

### S Tip (Harmonik Analiz)

P Tipinde yer alan tüm özelliklere ek olarak  
Harmonik Analiz (63)  
Dalga Yapısı Hata Kayıt

S  
type

Susol Compact Icu=50 & 60 kA, In=800-1600A,

## Standart Ürün Konfigürasyonu

MA	Motor Mekanizması	YOK
D0	Kapama Bobini	YOK
D0	Açtırma Bobini	YOK
FX	Kontakt Sayısı	4N04NK
NG5	Açtırma Ünitesi	NG5
U0	Düşük Gerilim Bobini	YOK
AL	Aksesuar	YOK

**IEC60947-2**  
**AC 415V/380V/220V**  
**Ics=%100 Icu**  
**LSIG Korumalı**

Farklı tip konfigürasyon talepleriniz için yetkili satış kanallarımızdan bilgi alabilirsiniz.

## Örnek Donatılı Ürün Konfigürasyonu

M2	Motor Mekanizması	AC/DC 200-250V
D2	Kapama Bobini	AC/DC 200-250V
D2	Açtırma Bobini	AC/DC 200-250V
FX	Kontakt Sayısı	4N04NK
NG5	Açtırma Ünitesi	NG5
U2	Düşük Gerilim Bobini	AC/DC 200-250V
AL	Aksesuar	YOK

Donatılı ürünler fabrikadan montajlı halde gelmekte olup, sipariş aşamasında belirtilmelidir.

## 3 Kutuplu Sabit Tip

Model	Anma Akımı (A)	Termik Ayar Sahası (A)	Kesme Kapasitesi	Sipariş Kodu	Açıklama	Liste Fiyatı (\$)
AN-08C3-06P	630	250-630	50 kA	Sorunuz!	AN-08C3-06P MADOD0FX NG5U0	3.233,00
AN-08C3-08P	800	320-800	50 kA	29400245	AN-08C3-08P MADOD0FX NG5U0	3.233,00
AN-16C3-10P	1000	400-1000	50 kA	Sorunuz!	AN-16C3-10P MADOD0FX NG5U0	3.530,00
AN-16C3-13P	1250	500-1250	50 kA	Sorunuz!	AN-16C3-13P MADOD0FX NG5U0	3.530,00
AN-16C3-16P	1600	640-1600	50 kA	29400244	AN-16C3-16P MADOD0FX NG5U0	3.530,00
AH-08C3-06H	630	250-630	60 kA	Sorunuz!	AH-08C3-06H MADOD0FX NG5U0	3.837,00
AH-08C3-08H	800	320-800	60 kA	29410133	AH-08C3-08H MADOD0FX NG5U0	3.837,00
AH-16C3-10H	1000	400-1000	60 kA	Sorunuz!	AH-16C3-10H MADOD0FX NG5U0	4.544,00
AH-16C3-13H	1250	500-1250	60 kA	Sorunuz!	AH-16C3-13H MADOD0FX NG5U0	4.544,00
AH-16C3-16H	1600	640-1600	60 kA	29410134	AH-16C3-16H MADOD0FX NG5U0	4.544,00

## 4 Kutuplu Sabit Tip

Model	Anma Akımı (A)	Termik Ayar Sahası (A)	Kesme Kapasitesi	Sipariş Kodu	Açıklama	Liste Fiyatı (\$)
AN-08C4-06P	630	250-630	50 kA	Sorunuz!	AN-08C4-06P MADOD0FX NG5U0	3.642,00
AN-08C4-08P	800	320-800	50 kA	29400242	AN-08C4-08P MADOD0FX NG5U0	3.642,00
AN-16C4-10P	1000	400-1000	50 kA	Sorunuz!	AN-16C4-10P MADOD0FX NG5U0	3.740,00
AN-16C4-13P	1250	500-1250	50 kA	Sorunuz!	AN-16C4-13P MADOD0FX NG5U0	3.740,00
AN-16C4-16P	1600	640-1600	50 kA	29400243	AN-16C4-16P MADOD0FX NG5U0	3.740,00
AH-08C4-06H	630	250-630	60 kA	Sorunuz!	AH-08C4-06H MADOD0FX NG5U0	4.158,00
AH-08C4-08H	800	320-800	60 kA	29410135	AH-08C4-08H MADOD0FX NG5U0	4.158,00
AH-16C4-10H	1000	400-1000	60 kA	Sorunuz!	AH-08C4-10H MADOD0FX NG5U0	5.377,00
AH-16C4-13H	1250	500-1250	60 kA	Sorunuz!	AH-08C4-13H MADOD0FX NG5U0	5.377,00
AH-16C4-16H	1600	640-1600	60 kA	29410136	AH-16C4-16H MADOD0FX NG5U0	5.377,00

## 3 Kutuplu Çekmeceli Tip

Model	Anma Akımı (A)	Termik Ayar Sahası (A)	Kesme Kapasitesi	Sipariş Kodu	Açıklama	Liste Fiyatı (\$)
AN-08C3-06A	630	250-630	50 kA	Sorunuz!	AN-08C3-06A MADOD0FX NG5U0	3.330,00
AN-08C3-08A	800	320-800	50 kA	29400234	AN-08C3-08A MADOD0FX NG5U0	3.330,00
AN-16C3-10A	1000	400-1000	50 kA	Sorunuz!	AN-16C3-10A MADOD0FX NG5U0	3.456,00
AN-16C3-13A	1250	500-1250	50 kA	Sorunuz!	AN-16C3-13A MADOD0FX NG5U0	3.456,00
AN-16C3-16A	1600	640-1600	50 kA	29400093	AN-16C3-16A MADOD0FX NG5U0	3.456,00
AH-08C3-06A	630	250-630	60 kA	Sorunuz!	AH-08C3-06A MADOD0FX NG5U0	3.567,00
AH-08C3-08A	800	320-800	60 kA	29410139	AH-08C3-08A MADOD0FX NG5U0	3.567,00
AH-16C3-10A	1000	400-1000	60 kA	Sorunuz!	AH-16C3-10A MADOD0FX NG5U0	4.274,00
AH-16C3-13A	1250	500-1250	60 kA	Sorunuz!	AH-16C3-13A MADOD0FX NG5U0	4.274,00
AH-16C3-16A	1600	640-1600	60 kA	29410140	AH-16C3-16A MADOD0FX NG5U0	4.274,00

## 4 Kutuplu Çekmeceli Tip

Model	Anma Akımı (A)	Termik Ayar Sahası (A)	Kesme Kapasitesi	Sipariş Kodu	Açıklama	Liste Fiyatı (\$)
AN-08C4-06A	630	250-630	50 kA	Sorunuz!	AN-08C4-06A MADOD0FX NG5U0	3.744,00
AN-08C4-08A	800	320-800	50 kA	29400233	AN-08C4-08A MADOD0FX NG5U0	3.744,00
AN-16C4-10A	1000	400-1000	50 kA	Sorunuz!	AN-16C4-10A MADOD0FX NG5U0	4.019,00
AN-16C4-13A	1250	500-1250	50 kA	Sorunuz!	AN-16C4-13A MADOD0FX NG5U0	4.019,00
AN-16C4-16A	1600	640-1600	50 kA	29400137	AN-16C4-16A MADOD0FX NG5U0	4.019,00
AH-08C4-06A	630	250-630	60 kA	Sorunuz!	AH-08C4-06A MADOD0FX NG5U0	3.888,00
AH-08C4-08A	800	320-800	60 kA	29410143	AH-08C4-08A MADOD0FX NG5U0	3.888,00
AH-16C4-10A	1000	400-1000	60 kA	Sorunuz!	AH-16C4-10A MADOD0FX NG5U0	5.107,00
AH-16C4-13A	1250	500-1250	60 kA	Sorunuz!	AH-16C4-13A MADOD0FX NG5U0	5.107,00
AH-16C4-16A	1600	640-1600	60 kA	29410144	AH-16C4-16A MADOD0FX NG5U0	5.107,00

## Çekmece Ünitesi

Model	Berber Kullanılan Kasalar	Kutup	Sipariş Kodu	Açıklama	Liste Fiyatı (\$)
Susol Compact	AN/AH-08-C3 ≈ AN/AH-16-C3	3 kutup	52073471092	AL-H16C3 AHES	1.660,00
Susol Compact	AN/AH-08-C4 ≈ AN/AH-16-C4	4 kutup	52073471096	AL-H16C4 AHES	1.874,00

## Yardımcı Donanımlar

### Motor Mekanizmaları (M)

Model	Motor Çalışma Gerilimi	Berber Kullanılan Şalterler	Sipariş Kodu	Açıklama	Liste Fiyatı (\$)	
	M2	AC/DC 200~250V	SUSOL & METASOL	72313460504	MOTOR,AC/DC 200~250V,AN,AS,AH-DEFG,A/S	502,00
	M4	DC 24~30V		72313460505	MOTOR,DC 24~30V,AN,AS,AH-DEFG,A/S	502,00
	M6	AC 380V		72313460507	MOTOR,AC 380~415V,AN,AS,AH-DEFG,A/S	502,00
	M2	AC/DC 200~250V	SUSOL COMPACT	72313471151	MOTOR,AC/DC 200~250V, AN,AH-DEFG	437,00
	M4	DC 24~30V		72313471152	MOTOR,DC 24~30V,AN,AH-DEFG	437,00
	M6	AC 380V		72313471154	MOTOR,AC 380~415V,AN,AH-DEFG	437,00

### Kapama Bobinleri (CC)

Model	Bobin Çalışma Gerilimi	Berber Kullanılan Şalterler	Sipariş Kodu	Açıklama	Liste Fiyatı (\$)	
	D4	DC24~30V	SUSOL & METASOL & SUSOL COMPACT	77123460206	DC24~30V CC,UVSHCC	129,00
	D5 & D7	DC48~60V,AC48V		77123460207	DC48~60V,AC48V CC,UVSHCC	129,00
	D1 & D3	AC/DC 100~130V		77123460208	ADC100~130V CC,UVSHCC	129,00
	D2	AC/DC 200~250V		77123460209	ADC200~250V CC,UVSHCC	129,00
	D6	AC380~480V		77123460210	AC380~480V CC,UVSHCC	129,00

### Açtırma Bobinleri (SHT)

Model	Bobin Çalışma Gerilimi	Berber Kullanılan Şalterler	Sipariş Kodu	Açıklama	Liste Fiyatı (\$)	
	D4	DC24~30V	SUSOL & METASOL & SUSOL COMPACT	77123460201	DC24~30V SHT,UVSHCC	107,00
	D5 & D7	DC48~60V,AC48V		77123460202	DC48~60V,AC48V SHT,UVSHCC	107,00
	D1 & D3	AC/DC 100~130V		77123460203	ADC100~130V SHT,UVSHCC	107,00
	D2	AC/DC 200~250V		77123460204	ADC200~250V SHT,UVSHCC	107,00
	D6	AC/DC 380~480V		77123460205	AC380~480V SHT,UVSHCC	107,00

### Düşük Gerilim Bobinleri (UVT)

Model	Bobin Çalışma Gerilimi	Berber Kullanılan Şalterler	Sipariş Kodu	Açıklama	Liste Fiyatı (\$)	
	U4	DC24~30V	SUSOL & METASOL & SUSOL COMPACT	77123460231	DC24~30V UVT,UVSHCC	139,00
	U5 & U7	DC48~60V,AC48V		77123460232	DC48~60V,AC48V UVT,UVSHCC	139,00
	U1 & U3	AC/DC 100~130V		77123460233	ADC100~130V UVT,UVSHCC	139,00
	U2	AC/DC 200~250V		77123460234	ADC200~250V UVT,UVSHCC	139,00
	U6	AC380~480V		77123460235	AC380~480V UVT,UVSHCC	139,00

### Düşük Gerilim Bobini Geciktirme Ünitesi (UDC)

Model	Bobin Çalışma Gerilimi	Berber Kullanılan Şalterler	Sipariş Kodu	Açıklama	Liste Fiyatı (\$)
	UDC	SUSOL & METASOL & SUSOL COMPACT	52773460271	UVT DELAY,DC48-60V,AC48V 0,5-3 sn gecikmeli	288,00
			52773460272	UVT DELAY,ADC100~130V 0,5-3 sn gecikmeli	288,00
			52773460273	UVT DELAY,ADC200~250V 0,5-3 sn gecikmeli	288,00
			52773460274	UVT DELAY,AC380~480V 0,5-3 sn gecikmeli	288,00

### Mekanik Kilitleme Modülü (MI)

Tanım	Model	Berber Kullanılan Şalterler	Sipariş Kodu	Açıklama	Liste Fiyatı (\$)
Mekanik Kilitleme Modülü	MI	Susol & Metasol	72313460791	Mekanik Kilitleme Modülü // 2WAY,AN,AS,AH-D,E,F,G,A/S	1.000,00
		Susol & Metasol	72313460510	Mekanik Kilitleme Modülü // 3WAY,AN,AS,AH-D,FA/S	2.070,00
		Susol & Metasol	72313460512	Mekanik Kilitleme Modülü // 3WAY,AN,AS,AH-E,G,A/S	2.070,00
		Susol Compact	56123471500	Mekanik Kilitleme Modülü // 2WAY,AN,AH,AR-C	1.767,00
		Susol Compact	56123471505	Mekanik Kilitleme Modülü // 3WAY,AN,AH,AR-C	874,00
		Susol Compact	56123460502	Mekanik Kilitleme Kablosu // WIRE-2WAY*	1.712,00
		Susol Compact	56123460503	Mekanik Kilitleme Kablosu // WIRE-3WAY*	1.033,00

### Yardımcı Kontak Blokları

Model	Tanım	Kontak	Berber Kullanılan Şalterler	Sipariş Kodu	Açıklama	Liste Fiyatı (\$)
AC	Yardımcı Kontak	3NO3NK	Susol & Metasol	72313461261	TOTAL ASS'Y,AUX SW,AC,3a3b,AN,AS,AH-D,F,AMP,CH	117,00
AX		3NO3NK	Susol & Metasol	72313461262	TOTAL ASS'Y,AUX SW,AX,3a3b,AN,AS,AH-D,F,AMP,CH	117,00
BC		5NO5NK	Susol & Metasol	72313461263	TOTAL ASS'Y,AUX SW,BC,5a5b,AN,AS,AH-D,F,AMP,CH	117,00
BX		5NO5NK	Susol & Metasol	72313461264	TOTAL ASS'Y,AUX SW,BX,5a5b,AN,AS,AH-D,F,AMP,CH	117,00
CC		6NO6NK	Susol & Metasol	72313461265	TOTAL ASS'Y,AUX SW,CC,6a6b,AN,AS,AH-D,F,AMP,CH	117,00
FX		4NO4NK	Susol Compact	72313471281	TOTAL ASS'Y,AUX SW,4C,AN,AH,AR-C	116,00

### Yardımcı Donanımlar

Model	Susol & Metasol	Susol Compact	Sipariş Kodu	Açıklama	Liste Fiyatı (\$)
OT	√	√	72313460375	OCR Test Cihazı	
ATS	√	√	0577000012	ATS Rölesi	5.712,00
AL	√		64273460254	Trip Alarm Kontakı + Manual Reset Butonu	149,00
K1	√		72313460553	Anahtarlı Kilit	177,00
		√	72313471611	Anahtarlı Kilit	195,00
B	√		72313460552	On/Off Buton Kilidi	102,00
		√	56773471612	On/Off Buton Kilidi	47,00
DF	√		64723460501	Kapı Çerçevesi, Çekmeceli şalter için	102,00
	√		64723460502	Kapı Çerçevesi, Sabit şalter için	102,00
DFC		√	64723471500	Kapı Çerçevesi, Sabit şalter için	102,00
		√	64723471501	Kapı Çerçevesi, Çekmeceli şalter için	102,00
DC	√		64623460501	IP54 Koruma Kapağı	888,00
		√	64623471402	IP54 Koruma Kapağı	847,00
C	√		72313460552	ON /OFF Sayıcı	102,00
		√	72313471551	ON /OFF Sayıcı	102,00
RCS	√		72313460558	Kapamaya Hazır Kontak	37,00
		√	72313471554	Kapamaya Hazır Kontak	37,00

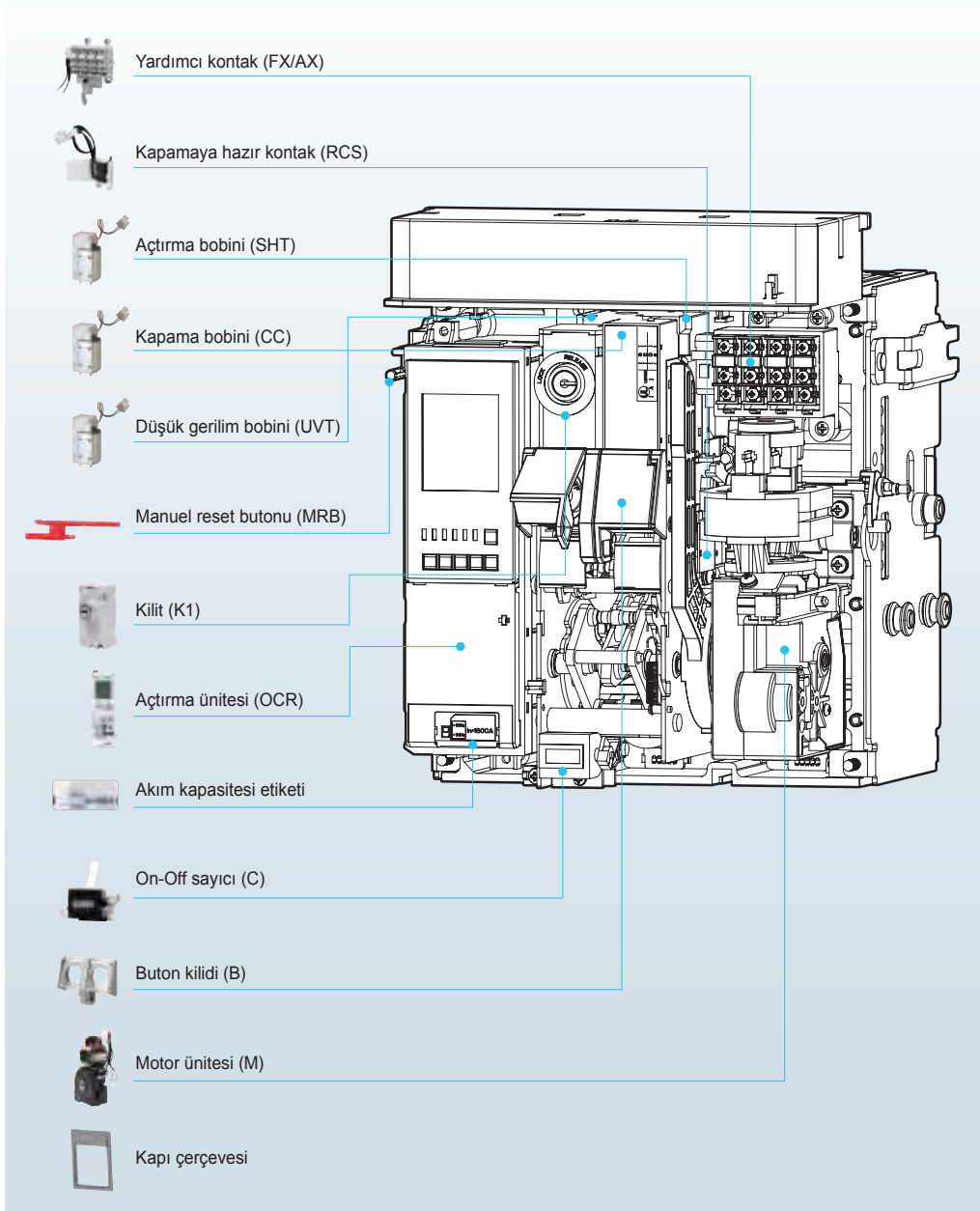

# Metasol Eksiksiz ve Kompakt Ürün Ailesi

Metasol Açık tip şalter ürün ailesi 6300 A kadar 4 farklı şasi boyutunda eksiksiz seçenekler sunar. Tasarım ve montaj aşamasında optimize çözümler sunmanız için geliştirilmiştir.

630 ~ 1600 AF (AN)  
630 ~ 2000 AF (AS)

2000 ~ 4000 AF (AS)

4000 ~

H = 430mm



W = 334mm



W = 412mm



(65kA)

(70kA)

70kA

85kA

## AN-06~16D

06	630AF
08	800AF
10	1000AF
13	1250AF
16	1600AF

Icu=Ics=65kA/500Vac  
W=334(3p), 419(4p)mm

## AS-06~20D

06	630AF
08	800AF
10	1000AF
13	1250AF
16	1600AF
20	2000AF

Icu=Ics=70kA/500Vac  
W=334(3p), 419(4p)mm

## AS-20~40E

20	2000AF
25	2500AF
32	3200AF
40	4000AF

Icu=Ics=85kA/500Vac  
W=412(3p), 527(4p)mm



5000 AF (AS)

4000 ~ 6300 AF (AS)



D=375mm

W = 629mm

W = 785mm

100kA ..... 120kA

### AS-50F

40	4000AF
50	5000AF

Icu=Ics=100kA/500Vac  
W=629(3p), 799(4p)mm

### AS-40~63G

40	4000AF
50	5000AF
63	6300AF

Icu=Ics=120kA/500Vac  
W=785(3p), 1015(4p)mm

- Standart L, S, I, G koruma
- 4 farklı şasi boyutu  
2000/4000/5000/6300AF
- 4 farklı açtırma rölesi tipi  
N/A/P/S
- N fazı akım taşıma kapasitesi: %100

## Sipariş Kodu Oluşturma

AS	10	D	3	10	J																																					
<table border="1"> <tr><th>Tip</th></tr> <tr><td>Şalter</td></tr> <tr><td>AN</td></tr> <tr><td>AS</td></tr> </table>	Tip	Şalter	AN	AS	<table border="1"> <tr><th>Şasi boyutu</th></tr> <tr><td>06 630AF</td></tr> <tr><td>08 800AF</td></tr> <tr><td>10 1000AF</td></tr> <tr><td>13 1250AF</td></tr> <tr><td>16 1600AF</td></tr> <tr><td>20 2000AF</td></tr> </table>	Şasi boyutu	06 630AF	08 800AF	10 1000AF	13 1250AF	16 1600AF	20 2000AF	<table border="1"> <tr><th>Faz sırası</th></tr> <tr><td>D 630~2000AF 3P/4P Standard RST(N)</td></tr> <tr><td>W 630~2000AF 4P Ters (N)RST</td></tr> </table>	Faz sırası	D 630~2000AF 3P/4P Standard RST(N)	W 630~2000AF 4P Ters (N)RST	<table border="1"> <tr><th>Kutup sayısı</th></tr> <tr><td>3 3P(D)</td></tr> <tr><td>4 4P(D, W)</td></tr> </table>	Kutup sayısı	3 3P(D)	4 4P(D, W)	<table border="1"> <tr><th>Anma akımı</th></tr> <tr><td>00 Koruma rölesi hariç</td></tr> <tr><td>02 200A</td></tr> <tr><td>04 400A</td></tr> <tr><td>06 630A</td></tr> <tr><td>08 800A</td></tr> <tr><td>10 1000A</td></tr> <tr><td>13 1250A</td></tr> <tr><td>16 1600A</td></tr> <tr><td>20 2000A</td></tr> </table>	Anma akımı	00 Koruma rölesi hariç	02 200A	04 400A	06 630A	08 800A	10 1000A	13 1250A	16 1600A	20 2000A	<table border="1"> <tr><th>Bağlantı tipi</th></tr> <tr><td>Çekmeceli tip</td></tr> <tr><td>J Manuel bağlantı</td></tr> <tr><td>A Otomatik bağlantı</td></tr> <tr><td>Sabit tip</td></tr> <tr><td>H Yatay</td></tr> <tr><td>V Dikey</td></tr> <tr><td>M Yatay / Dikey</td></tr> <tr><td>N Dikey / Yatay</td></tr> <tr><td>P Önden</td></tr> </table>	Bağlantı tipi	Çekmeceli tip	J Manuel bağlantı	A Otomatik bağlantı	Sabit tip	H Yatay	V Dikey	M Yatay / Dikey	N Dikey / Yatay	P Önden
Tip																																										
Şalter																																										
AN																																										
AS																																										
Şasi boyutu																																										
06 630AF																																										
08 800AF																																										
10 1000AF																																										
13 1250AF																																										
16 1600AF																																										
20 2000AF																																										
Faz sırası																																										
D 630~2000AF 3P/4P Standard RST(N)																																										
W 630~2000AF 4P Ters (N)RST																																										
Kutup sayısı																																										
3 3P(D)																																										
4 4P(D, W)																																										
Anma akımı																																										
00 Koruma rölesi hariç																																										
02 200A																																										
04 400A																																										
06 630A																																										
08 800A																																										
10 1000A																																										
13 1250A																																										
16 1600A																																										
20 2000A																																										
Bağlantı tipi																																										
Çekmeceli tip																																										
J Manuel bağlantı																																										
A Otomatik bağlantı																																										
Sabit tip																																										
H Yatay																																										
V Dikey																																										
M Yatay / Dikey																																										
N Dikey / Yatay																																										
P Önden																																										
<table border="1"> <tr><td>20 2000AF</td></tr> <tr><td>25 2500AF</td></tr> <tr><td>32 3200AF</td></tr> <tr><td>40 4000AF</td></tr> </table>	20 2000AF	25 2500AF	32 3200AF	40 4000AF	<table border="1"> <tr><td>E 2000~4000AF 3P/4P Standard RST(N)</td></tr> <tr><td>X 2000~4000AF 4P Ters (N)RST</td></tr> </table>	E 2000~4000AF 3P/4P Standard RST(N)	X 2000~4000AF 4P Ters (N)RST	<table border="1"> <tr><td>3 3P(E)</td></tr> <tr><td>4 4P(E, X)</td></tr> </table>	3 3P(E)	4 4P(E, X)	<table border="1"> <tr><td>02 200A</td></tr> <tr><td>04 400A</td></tr> <tr><td>06 630A</td></tr> <tr><td>08 800A</td></tr> <tr><td>10 1000A</td></tr> <tr><td>13 1250A</td></tr> <tr><td>16 1600A</td></tr> <tr><td>20 2000A</td></tr> <tr><td>25 2500A</td></tr> <tr><td>32 3200A</td></tr> <tr><td>40 4000A</td></tr> </table>	02 200A	04 400A	06 630A	08 800A	10 1000A	13 1250A	16 1600A	20 2000A	25 2500A	32 3200A	40 4000A																				
20 2000AF																																										
25 2500AF																																										
32 3200AF																																										
40 4000AF																																										
E 2000~4000AF 3P/4P Standard RST(N)																																										
X 2000~4000AF 4P Ters (N)RST																																										
3 3P(E)																																										
4 4P(E, X)																																										
02 200A																																										
04 400A																																										
06 630A																																										
08 800A																																										
10 1000A																																										
13 1250A																																										
16 1600A																																										
20 2000A																																										
25 2500A																																										
32 3200A																																										
40 4000A																																										
<table border="1"> <tr><td>40 4000AF</td></tr> <tr><td>50 5000AF</td></tr> </table>	40 4000AF	50 5000AF	<table border="1"> <tr><td>F 4000/5000AF 3P/4P Standard RST(N)</td></tr> <tr><td>Y 4000/5000AF 4P Ters (N)RST</td></tr> </table>	F 4000/5000AF 3P/4P Standard RST(N)	Y 4000/5000AF 4P Ters (N)RST	<table border="1"> <tr><td>3 3P(F)</td></tr> <tr><td>4 4P(F, Y)</td></tr> </table>	3 3P(F)	4 4P(F, Y)	<table border="1"> <tr><td>40 4000A</td></tr> <tr><td>50 5000A</td></tr> </table>	40 4000A	50 5000A																															
40 4000AF																																										
50 5000AF																																										
F 4000/5000AF 3P/4P Standard RST(N)																																										
Y 4000/5000AF 4P Ters (N)RST																																										
3 3P(F)																																										
4 4P(F, Y)																																										
40 4000A																																										
50 5000A																																										
<table border="1"> <tr><td>40 4000AF</td></tr> <tr><td>50 5000AF</td></tr> <tr><td>63 6300AF</td></tr> </table>	40 4000AF	50 5000AF	63 6300AF	<table border="1"> <tr><td>G 4000/5000/6300AF 3P/4P Standard RST(N)</td></tr> <tr><td>Z 4000/5000/6300AF 4P Ters (N)RST</td></tr> </table>	G 4000/5000/6300AF 3P/4P Standard RST(N)	Z 4000/5000/6300AF 4P Ters (N)RST	<table border="1"> <tr><td>3 3P(G)</td></tr> <tr><td>4 4P(G, Z)</td></tr> </table>	3 3P(G)	4 4P(G, Z)	<table border="1"> <tr><td>40 4000A</td></tr> <tr><td>50 5000A</td></tr> <tr><td>63 6300A</td></tr> </table>	40 4000A	50 5000A	63 6300A																													
40 4000AF																																										
50 5000AF																																										
63 6300AF																																										
G 4000/5000/6300AF 3P/4P Standard RST(N)																																										
Z 4000/5000/6300AF 4P Ters (N)RST																																										
3 3P(G)																																										
4 4P(G, Z)																																										
40 4000A																																										
50 5000A																																										
63 6300A																																										

## Çekmece Ünitesi

AL	N16D	3	J	H	E	N
Çekmece ünitesi	Şasi boyutu	Kutup sayısı	Bağlantı tipi	Montaj	Güvenlik bariyeri	Ark kapağı
	N06~16D AN-06~16D S06~16D AS-06~16D S20D AS-20D S20~25E AS-20~25E S32E AS-32E S40E AS-40E S40~50F AS-40~50F S40~50G AS-40~50G S63G AS-63G	3 3P 4 4P	A Otomatik J Manuel	H Yatay tip V Dikey tip M Yatay / Dikey N Dikey / Yatay P Önden	E Güvenlik bariyersiz F Güvenlik bariyerli	N Ark kapaksız S Ark kapaklı

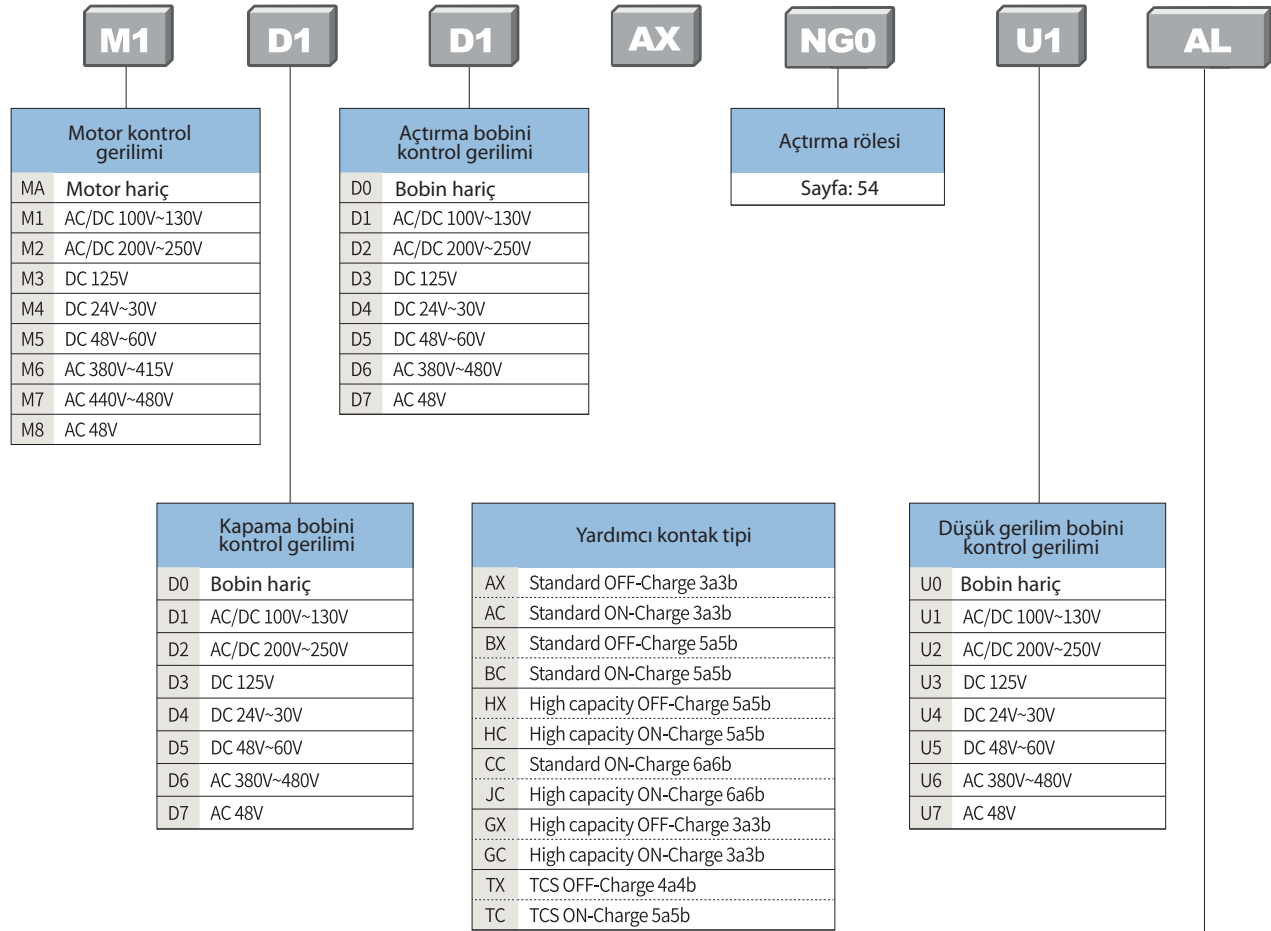

Opsiyon	Açıklama	Opsiyon	Açıklama
AL	AL1+MRB	B2	B2
A1	AL1+MRB+RES (AC110~130V)	M	MI
A2	AL1+AL2+MRB		
A3	AL1+MRB+RES (DC110~125V)	D	DI
A4	AL1+MRB+RES (AC200~250V)		
A5	AL1+MRB+Auto reset	K	K1
A6	AL1+AL2+MRB+Auto reset	K2	K2
A7	AL1+MRB+RES (DC110~125V)+Auto reset	K3	K3
A8	AL1+MRB+RES (AC200~250V)+Auto reset	K4	K4
A9	AL1+MRB+RES (AC110~130V)+Auto reset	R	RCS
Y2	AL1+AL2+MRB (2b contact)	T	TM
Y6	AL1+AL2+MRB+Auto reset (2b contact)	H1	SHT2
Z2	AL1+AL2+MRB (1a1b contact)	H2	
Z6	AL1+AL2+MRB+Auto reset (1a1b contact)	H3	
C	C Counter	H4	
S	CS2 Charge switch communication	H5	
B	B On/Off Button lock	H6	
B1	B1 On/Off Button lock	H7	
(-V)	Without VDM module (External type VDM is required to order)		

On/Off Button lock

Mechanical interlock

Door Interlock

Door Interlock(Catcher type)

Mechanism operated cell switch

Key lock

Key Interlock set

Key lock double

Key lock (Same key)

Ready to close switch

Temperature monitoring

AC/DC 100~130V

AC/DC 200~250V

DC 125V

DC 24~30V

DC 48~60V

AC 380~480V

AC 48V

Double shunt coil

Koruma Röleleri

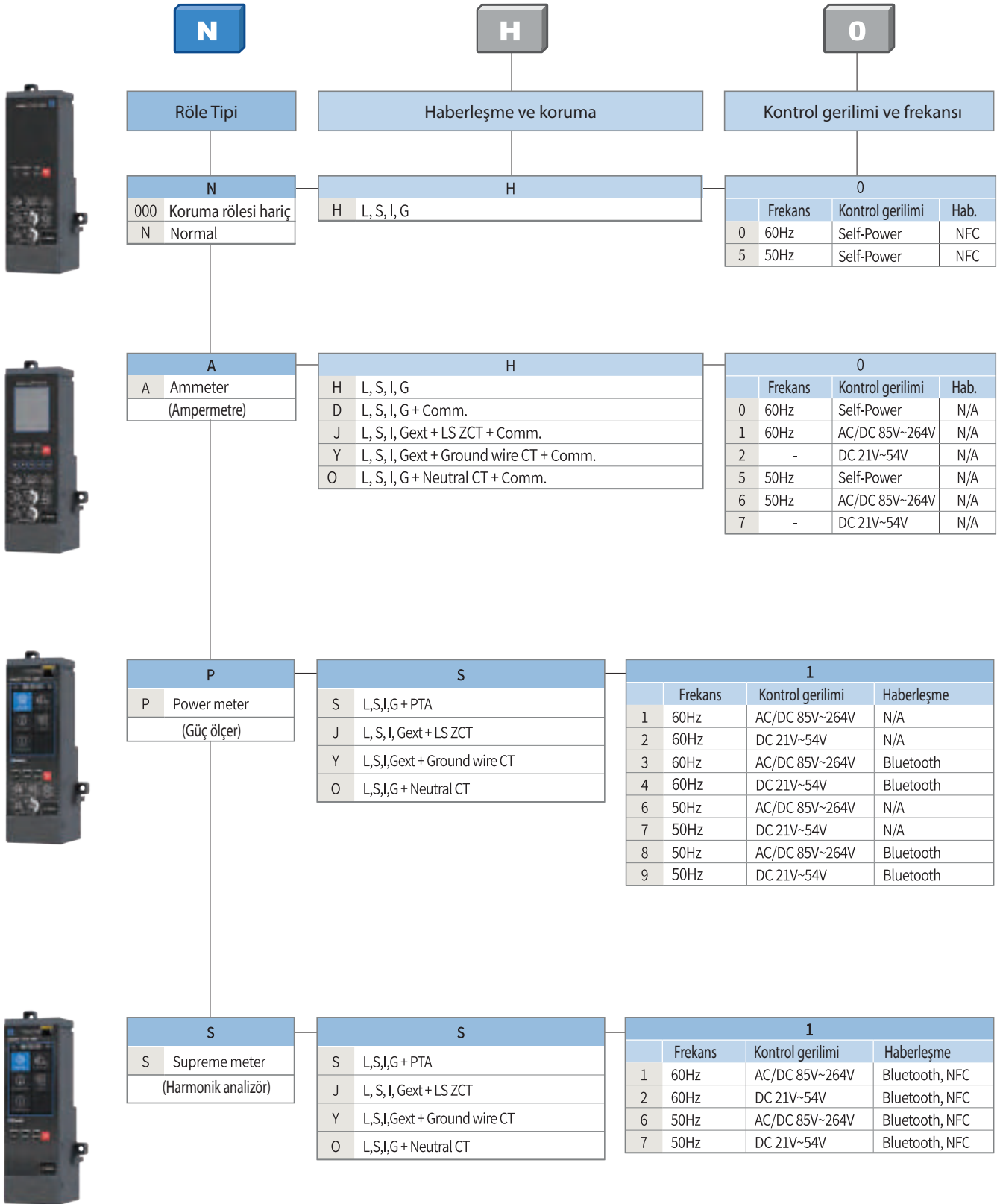

## Standart Ürün Konfigürasyonu

MA	Motor Mekanizması	YOK
D0	Kapama Bobini	YOK
D0	Açtırma Bobini	YOK
FX	Kontak Sayısı	4NO4NK
NG5	Açtırma Ünitesi	NG5
U0	Düşük Gerilim Bobini	YOK
AL	Aksesuar	YOK

**IEC60947-2**  
**AC 415V/380V/220V**  
**Ics=%100 Icu**  
**LSIG Korumalı**

Farklı tip konfigürasyon talepleriniz için yetkili satış kanallarımızdan bilgi alabilirsiniz.

## Örnek Donatılı Ürün Konfigürasyonu

M2	Motor Mekanizması	AC/DC 200-250V
D2	Kapama Bobini	AC/DC 200-250V
D2	Açtırma Bobini	AC/DC 200-250V
AX	Kontak Sayısı	3NO3NK
NG5	Açtırma Ünitesi	NG5
U2	Düşük Gerilim Bobini	AC/DC 200-250V
AL	Aksesuar	YOK

Donatılı ürünler fabrikadan montajlı halde gelmekte olup, sipariş aşamasında belirtilmelidir.

## 3 Kutuplu Sabit Tip

Model	Anma Akımı (A)	Termik Ayar Sahası (A)	Kesme Kapasitesi	Sipariş Kodu Eski	Sipariş Kodu	Açıklama	Liste Fiyatı (\$)
AN-06D3-06H	630	200-630	65 kA	28951118	28951302	AN-06D3-06H MADOD0AX NH5U0AL	4.512,00
AN-08D3-08H	800	320-800	65 kA	28960842	28961046	AN-08D3-08H MADOD0AX NH5U0AL	4.512,00
AN-10D3-10H	1000	400-1000	65 kA	28971147	28971436	AN-10D3-10H MADOD0AX NH5U0AL	4.465,00
AN-13D3-13H	1250	500-1250	65 kA	28981123	28981460	AN-13D3-13H MADOD0AX NH5U0AL	4.465,00
AN-16D3-16H	1600	640-1600	65 kA	28991406	28991859	AN-16D3-16H MADOD0AX NH5U0AL	4.465,00
AS-20D3-20V	2000	800-2000	70 kA	29080720	29080720	AS-20D3-20V MADOD0AX NH5U0AL	5.074,00
AS-20E3-20H	2000	800-2000	85 kA	29080938	29080938	AS-20E3-20H MADOD0AX NH5U0AL	5.967,00
AS-25E3-25H	2500	1000-2500	85 kA	29091217	29091645	AS-25E3-25H MADOD0AX NH5U0AL	6.777,00
AS-32E3-32H	3200	1250-3200	85 kA	29101090	29101396	AS-32E3-32H MADOD0AX NH5U0AL	7.391,00
AS-40E3-40V	4000	1600-4000	85 kA	29111404	29111762	AS-40E3-40V MADOD0AX NH5U0AL	12.470,00
AS-50F3-50H	5000	2000-5000	100kA	29120869	29121154	AS-50F3-50H MADOD0AX NH5U0AL	14.670,00
AS-63G3-63H	6300	2500-6300	120kA	29130334	29130462	AS-63G3-63H MADOD0AX NH5U0AL	23.242,00

## 4 Kutuplu Sabit Tip

Model	Anma Akımı (A)	Termik Ayar Sahası (A)	Kesme Kapasitesi	Sipariş Kodu Eski	Sipariş Kodu	Açıklama	Liste Fiyatı (\$)
AN-06D4-06H	630	200-630	65 kA	28951117	28951305	AN-06D4-06H MADOD0AX NH5U0AL	5.112,00
AN-08D4-08H	800	320-800	65 kA	28960843	28961048	AN-08D4-08H MADOD0AX NH5U0AL	5.112,00
AN-10D4-10H	1000	400-1000	65 kA	28971144	28971438	AN-10D4-10H MADOD0AX NH5U0AL	5.158,00
AN-13D4-13H	1250	500-1250	65 kA	28981122	28981456	AN-13D4-13H MADOD0AX NH5U0AL	5.158,00
AN-16D4-16H	1600	640-1600	65 kA	28991405	28991856	AN-16D4-16H MADOD0AX NH5U0AL	5.158,00
AS-20D4-20V	2000	800-2000	70 kA	29081293	29081293	AS-20D4-20V MADOD0AX NH5U0AL	5.944,00
AS-20E4-20H	2000	800-2000	85 kA	29081526	29081526	AS-20E4-20H MADOD0AX NH5U0AL	5.967,00
AS-25E4-25H	2500	1000-2500	85 kA	29091216	29091644	AS-25E4-25H MADOD0AX NH5U0AL	7.084,00
AS-32E4-32H	3200	1250-3200	85 kA	29101089	29101395	AS-32E4-32H MADOD0AX NH5U0AL	8.619,00
AS-40E4-40V	4000	1600-4000	85 kA	29111405	29111771	AS-40E4-40V MADOD0AX NH5U0AL	15.060,00
AS-50F4-50H	5000	2000-5000	100kA	29120871	29120871	AS-50F4-50H MADOD0AX NH5U0AL	17.684,00
AS-63G4-63H	6300	2500-6300	120kA	29130335	29130456	AS-63G4-63H MADOD0AX NH5U0AL	26.981,00

### 3 Kutuplu Çekmeceli Tip

Model	Anma Akımı (A)	Termik Ayar Sahası (A)	Kesme Kapasitesi	Sipariş Kodu Eski	Sipariş Kodu	Açıklama	Liste Fiyatı (\$)
AN-06D3-06A	630	200-630	65 kA	28450677	28450677.N	AN-06D3-06A MADODOAX NH5U0AL	4.512,00
AN-08D3-08A	800	320-800	65 kA	28450678	28450678.N	AN-08D3-08A MADODOAX NH5U0AL	4.512,00
AN-10D3-10A	1000	400-1000	65 kA	28450679	28450679.N	AN-10D3-10A MADODOAX NH5U0AL	4.465,00
AN-13D3-13A	1250	500-1250	65 kA	28450680	28450680.N	AN-13D3-13A MADODOAX NH5U0AL	4.465,00
AN-16D3-16A	1600	640-1600	65 kA	28991506	28991506.N	AN-16D3-16A MADODOAX NH5U0AL	4.465,00
AS-20D3-20A	2000	800-2000	70 kA	28660141	28660141.N	AS-20E3-20A MADODOAX NH5U0AL	5.074,00
AS-25E3-25A	2500	1000-2500	85 kA	29091287	29091287.N	AS-25E3-25A MADODOAX NH5U0AL	6.777,00
AS-32E3-32A	3200	1250-3200	85 kA	29101108	29101108.N	AS-32E3-32A MADODOAX NH5U0AL	7.391,00
AS-40E3-40A	4000	1600-4000	85 kA	28890215	28890215.N	AS-40E3-40A MADODOAX NH5U0AL	12.470,00
AS-50F3-50A	5000	2000-5000	100kA	29120872	29120872.N	AS-50F3-50A MADODOAX NH5U0AL	14.670,00
AS-63G3-63A	6300	2500-6300	120kA	29240088	29240088.N	AS-63G3-63A MADODOAX NH5U0AL	23.242,00

### 4 Kutuplu Çekmeceli Tip

Model	Anma Akımı (A)	Termik Ayar Sahası (A)	Kesme Kapasitesi	Sipariş Kodu Eski	Sipariş Kodu	Açıklama	Liste Fiyatı (\$)
AN-06D4-06A	630	200-630	65 kA	28450682	28450682.N	AN-06D4-06A MADODOAX NH5U0AL	5.028,00
AN-08D4-08A	800	320-800	65 kA	28450683	28450683.N	AN-08D4-08A MADODOAX NH5U0AL	5.028,00
AN-10D4-10A	1000	400-1000	65 kA	28450684	28450684.N	AN-10D4-10A MADODOAX NH5U0AL	5.395,00
AN-13D4-13A	1250	500-1250	65 kA	28450685	28450685.N	AN-13D4-13A MADODOAX NH5U0AL	5.395,00
AN-16D4-16A	1600	640-1600	65 kA	28991080	28991080.N	AN-16D4-16A MADODOAX NH5U0AL	5.395,00
AS-20D4-20A	2000	800-2000	70 kA	29080865	29080865.N	AS-20E4-20A MADODOAX NH5U0AL	5.800,00
AS-25E4-25A	2500	1000-2500	85 kA	29210547	29210547.N	AS-25E4-25A MADODOAX NH5U0AL	6.944,00
AS-32E4-32A	3200	1250-3200	85 kA	29210548	29210548.N	AS-32E4-32A MADODOAX NH5U0AL	7.484,00
AS-40E4-40A	4000	1600-4000	85 kA	28890216	28890216.N	AS-40E4-40A MADODOAX NH5U0AL	8.870,00
AS-50F4-50A	5000	2000-5000	100kA	28899999	28899999.N	AS-50F4-50A MADODOAX NH5U0AL	11.674,00
AS-63G4-63A	6300	2500-6300	120kA	29240094	29240094.N	AS-63G4-63A MADODOAX NH5U0AL	23.191,00

### Çekmece Ünitesi

Model	Beraber Kullanılan Kasalar	Kutup	Sipariş Kodu	Açıklama	Liste Fiyatı (\$)
Metasol	AN-06D3 ≈ AN-16D3	3	72313461441	AL-N16D3-AHES	2.079,00
Metasol	AS-20D3	3	72313461499	AL-S20D3-AVES	2.600,00
Metasol	AS-20E3 ≈ AH-25E3	3	72313463442	AL-S25E3-AHES	3.056,00
Metasol	AS-32E3	3	72313463823	AL-S32E3-AHES	3.367,00
Metasol	AS-40E3	3	72313463473	AL-S40E3-AVES	6.153,00
Metasol	AS-40F3 ≈ AS50F3	3	72313465481	AL-S50F3-AHES	7.721,00
Metasol	AS-63G3	3	72313465649	AL-S63G3-AHES	10.014,00
Metasol	AN-06D4 ≈ AN-16D4	4	72313462441	AL-N16D4-AHES	2.451,00
Metasol	AS-20D4	4	72313462499	AL-S20D4-AVES	6.712,00
Metasol	AS-20E4 ≈ AH-25E4	4	72313464442	AL-S25E4-AHES	3.786,00
Metasol	AS-32E4	4	72313464539	AL-S32E4-AHES	4.167,00
Metasol	AS-40E4	4	72313464473	AL-S40E4-AVES	7.963,00
Metasol	AS-40F4 ≈ AS50F4	4	72313465482	AL-S50F4-AHES	9.991,00
Metasol	AS-63G4	4	72313465650	AL-S63G4-AHES	12.874,00

**Beklentinin  
Ötesinde**

**™ Solar Uygulamalar İçin  
Devre Kesici Çözümleri**

**LS** ELECTRIC

## Enerji Depolama Sistemleri

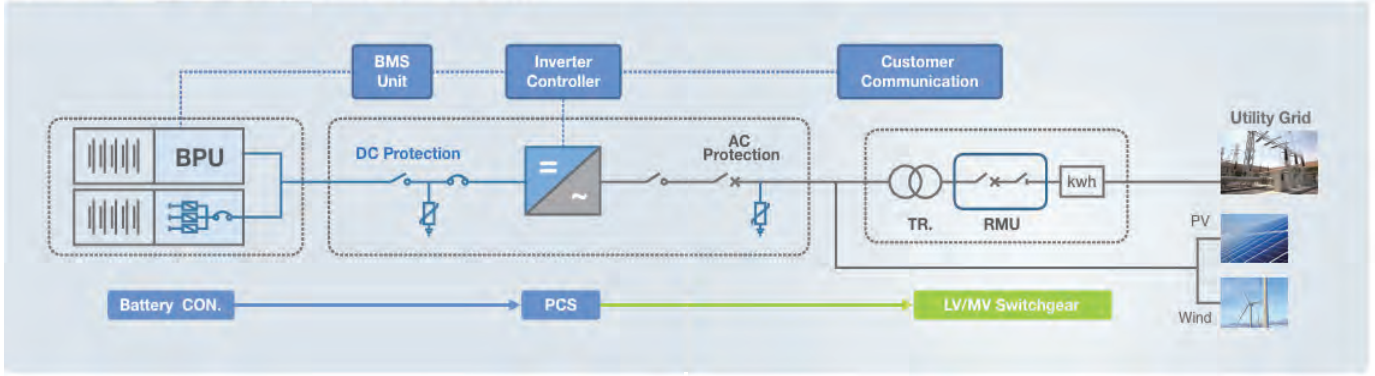

## Solar Enerji Üretim Tesisleri

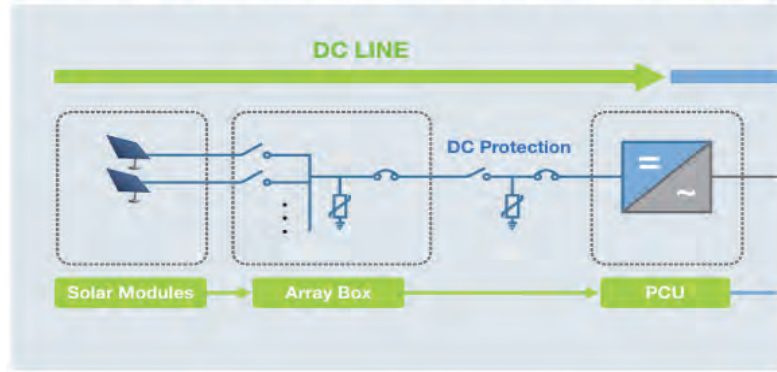

### DC Kompakt Şalter



#### TD100~TS800

- In 16~800A
- Ue DC 500~1500V
- Icu 40kA

### DC Kompakt Şalter



#### TS1600NA

- In 1000~1600A
- Ue DC 1150V
- Icw 25kA 1s

### Açık Tip Ayırıcı



#### DDH / DDV

- In 800~4000AF
- Ue DC 750~1500V
- Icw 100kA 1s

### DC Sigorta



#### BK63H

- In 1~63A
- Ue DC 250~1000V
- Icu 10kA

### DC Kontaktör



#### MD-30a, 60a, 100a

- Ie 120, 100, 60, 35A
- Ue DC 125,250,500V,1000V
- DC-2~5, DC-1 ratings
- 3.7kW~22kW

### Yüksek Gerilim DC Röle



#### GPR010~GPR-H500-A

- Ie 10~500A
- Ue 450~1500V

### DC Parafudr



#### BK20S-DC1500

- Un DC 110~1500V
- Up ≤1.0~4.5kV
- I<sub>max</sub> 40kA
- t<sub>a</sub> <25ns

## Rüzgar Santralleri

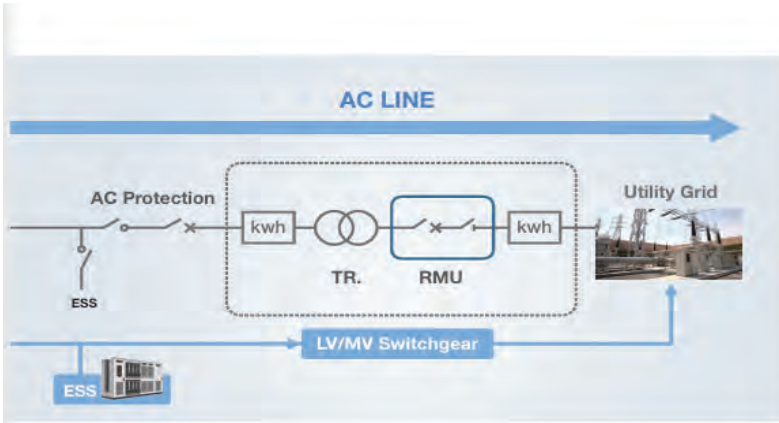
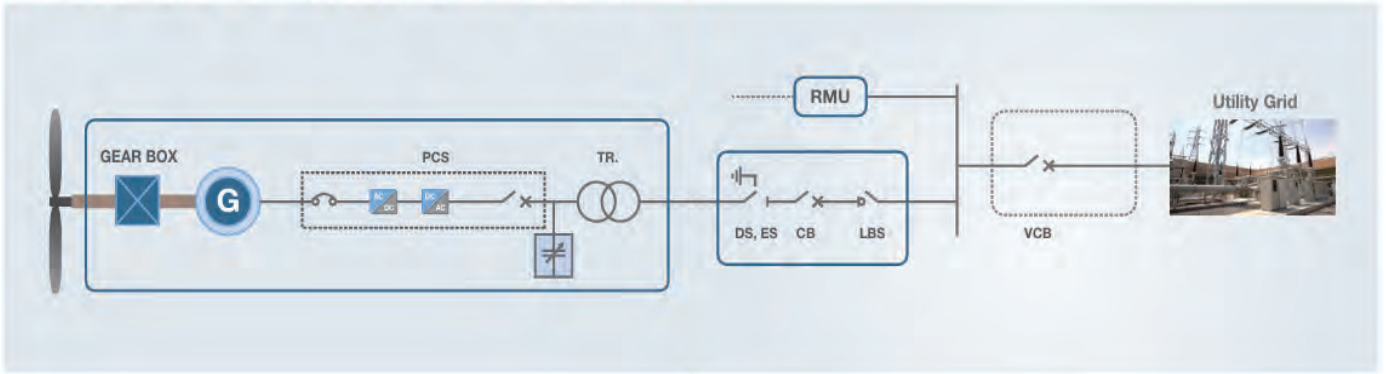

### Kompakt Şalter



#### TS1000~1600

- In 1000~1600A
- Icu 50~150kA
- AC 380/415V

### Kontaktör



#### MC-1260a, 2650a

- Ie 1260~2650A
- Ue AC 1000V
- Coil: AC 100~240V  
DC 100~220V

### Dağıtım Trafosu



- Rated Power
  - Up to 25MVA
- Rated Voltage
  - Primary: Up to 36kV
  - Secondary: Up to 1200V

### RMU



- Rated Voltage: Up to 36kV
- Ir: 630A
- Isc 21kA/3s
- M1/E3
- IAC AFAL 21kA/0.5s

### Açık Tip Şalter



#### AH

- In 630~6300A
- Icu 65~150kA
- Ue 690V

### XGIPAM



- XGIPAM Bay, F, M, T, DG
- PT : 110V, CT : 5A,  
ZCT : 1.5mA
- AC110V, DC110~125V

### Güç Trafosu



- Rated Power
  - Up to 80MVA
- Rated Voltage
  - Up to 72kV

### Paket Çözümler



RMU+TR+LV



RMU+TR+PCU

**Susol**

## AÇIK TIP ŞALTERLER 800/900/1000/1150VAC

LS ELECTRIC'in en yeni AV ve AW serisi, açık tip şalterler, güneş enerji santralleri, enerji depolama sistemleri ve rüzgar enerji santrallerinin yanı sıra yüksek rakım, yüksek sıcaklık gibi zorlu çalışma koşulları için ideal bir çözümdür.

Ayrıca, Akıllı Trip Üniteleri sayesinde endüstriyel IT sistemleri ile entegrasyon kurulmasına imkan sağlar.



## Şasi Seçenekleri ve Kesme Kapasiteleri:

G-Tipi Şasi : ~ 6300 AF

E-Tipi Şasi : ~ 4000 AF

D-Tipi Şasi : ~ 2000 AF

C-Tipi Şasi : ~ 1600 AF

## Uygulama Alanları:

Yeni AV/AW serisi açık tip şalterler, Güneş Enerji ve Rüzgar Enerji santrallerinin yanı sıra yüksek rakım, yüksek sıcaklık gibi zorlu çevre koşullarında kullanılmak üzere optimize edilmiştir.

## Gelişmiş Koruma ve İzleme:

G,D, E tipi şasiler için üretilmiş olan yeni nesil açtırma üniteleri (Smart Trip Unit-STU) ile gelişmiş koruma ve ölçüm olanakları.

## Yüksek Ölçüm Hassasiyeti:

Akım/Gerilim : 0.5%

Güç : Class 1.0



Akım Kapasitesi			AW-16C	AW-20D	AW-40E	AW-63G
			~ 1600AF	~ 2000AF	~ 4000AF	~ 6300AF
Anma Akımı (In)	40 (A)	(A)	400 / 630 / 800 / 1000 / 1250 / 1600	200 / 400 / 630 / 800 / 1000 / 1250 / 1600 / 2000	400 / 630 / 800 / 1000 / 1250 / 1600 / 2000 / 2500 / 3200 / 4000	2000 / 2500 / 3200 / 4000 / 5000 / 6300
Kısa Devre Kesme	1150V	(kA)	-	-	-	-
	1000V	(kA)	-	-	-	-
Kapasitesi (Icu)	900V	(kA)	-	42	50	85
	800V	(kA)	40	50	65	85

\*AW-08/16C IT Sistemlerinde kullanılabilir.

Akım Kapasitesi			AV-20D	AV-40E	AV-63G
			~ 2000AF	~ 4000AF	~ 6300AF
Anma Akımı (In)	40 (A)	(A)	200 / 400 / 630 / 800 / 1000 / 1250 / 1600 / 2000	400 / 630 / 800 / 1000 / 1250 / 1600 / 2000 / 2500 / 3200 / 4000	2000 / 2500 / 3200 / 4000 / 5000 / 6300
Kısa Devre Kesme	1150V	(kA)	30	50	65
	1000V	(kA)	42	65	85
Kapasitesi (Icu)	900V	(kA)	50	75	85
	800V	(kA)	50	75	85

\*AV Serisi IT Sistemlerinde kullanılabilir.

690/800/1000 VAC

Yenilenebilir Enerji ve Yüksek Rakım Uygulamaları için



## Satış Şartları

LS Elektrik San. Tic. Ltd. Şti. ihbarda bulunmaksızın fiyat listesinde bulunan ürünlerin teknik özelliklerinde ve fiyatlarında değişiklik yapma hakkını saklı tutar.

Fiyatlarımıza KDV dahil değildir.

Fiyat listesinde yer almayan ürünler için yetkili satış kanallarımız ile temasa geçebilirsiniz.

Fiyat listesinde yer alan teknik değerler genel bilgi amaçlıdır. Montaj ve işletme şartları için kullanım kitapçıklarındaki bilgiler geçerlidir.

Tüm ürünlerimiz imalat hatalarına karşı bir yıl garantilidir.

Ürünler minimum sipariş adeti ve katları şeklinde sipariş edilir.



[www.ls-electric.com](http://www.ls-electric.com)

■ **Yönetim Merkezi**

127 LS-ro (Hogye-dong) Dongan-gu, Anyang-si, Gyeonggi-Do, 14119, Korea

■ **LS Elektrik Türkiye**

42 Maslak Plaza A Blok Kat.14 D.8 Maslak 34485 Sarıyer, İstanbul - Türkiye

Tel. : +90 212 806 1252

e-posta: [turkey@ls-electric.com](mailto:turkey@ls-electric.com)

web : [www.ls-elektrik.com.tr](http://www.ls-elektrik.com.tr)